

Planar® UltraRes™ L Series 122"



URL122-MFT

Copyright © June 2024 by Planar Systems, Inc.
All rights reserved.

This document may not be copied in any form without permission from Planar. Information in this document is subject to change without notice.

Trademark Credits

Windows™ is a trademark of Microsoft Corp.

The terms HDMI, HDMI High-Definition Multimedia Interface, HDMI Trade dress and the HDMI Logos are trademarks or registered trademarks of HDMI Licensing Administrator, Inc. All other companies are trademarks or registered trademarks of their respective companies.

Disclaimer

The information contained in this document is subject to change without notice. Planar Systems, Inc. makes no warranty of any kind with regard to this material. While every precaution has been taken in the preparation of this manual, the Company shall not be liable for errors or omissions contained herein or for incidental or consequential damages in connection with the furnishing, performance, or use of this material.

Warranty and Service Plans

Planar warranty and service plans helps to maximize your investment by providing great support, display uptime, and performance optimization. From post-sale technical support, to a full suite of depot services, our services are performed by trained employees. When purchasing a Planar product, you get more than a display; you get the service and support you need to maximize your investment. To find the latest warranty and service information regarding your Planar product, please visit <http://www.planar.com/support>

Part Number: 020-1435-00A

Table of Contents

Introduction	6
1. Safety Information.....	7
2. Safety Precautions.....	7
2.1 Important Safety Instructions.....	8
2.2 Informations sur la sécurité	9
2.3 Précautions de sécurité	9
2.4 Consignes de sécurité importantes	10
3. Recommended Usage	11
3.1 Warranty Coverage	11
3.2 Important Waste Disposal Information	11
3.3 Normal Usage Guidelines.....	12
Unpacking and Checking Accessories.....	13
4. Package Contents	13
5. Accessory Kit.....	15
6. Optional Accessories	18
7. Optional Rolling Stand Crate	18
8. Planar UltraRes L Series – Standard Inputs	20
Installing the Display	21
9. Before Beginning	21
9.1 Tools/Equipment List	21
9.2 Other Things That May Be Needed	21
9.3 Plan the Installation	21
9.4 Prepare the Installation Location	22
9.5 Cable Length Recommendations	22
10. Assembly	23
10.1 Assembling Mount Bars.....	23
10.2 Assembling Rolling Floor Stand	24
10.3 Installing Mount Bars to Rolling Floor Stand	30
10.4 Preparing the Wall for Wall Mounting	32
10.5 Installing the Mount Bars on the Wall	33
10.6 Installing LED Columns	34
10.7 Assembling and Installing Electronic Box.....	41
10.8 Powering up and Test Display	49
10.9 Assembling and Installing Front Cover.....	50
10.10 Installing Side and Top Trim Parts	56
11. LED Module Removal.....	63
12. Last Column Installation in Recess.....	64
13. Adjusting Module Flatness.....	65
14. Mounting a Peripheral Device.....	68
Operating the Display	69
15. OSD Keypad.....	69
16. Remote Control Receiver	70
17. LED Indicators	71
18. Using the Remote Control	72
18.1 Changing Batteries	73

19.	IR Command Protocol.....	75
19.1	Hex Codes.....	76
19.2	Locking the Keypad and IR Remote.....	78
19.3	Unlocking the Keypad and IR Remote	78
19.4	Changing the IR Remote Code Set.....	78
19.5	Turning the Display On.....	78
19.6	Turning the Display Off.....	78
19.7	Adjusting the Volume.....	79
19.8	Selecting Layouts and Input Sources.....	79
19.9	Navigating Through the Menus	80
20.	Inputs and Views Menu	81
20.1	Image Adjust Menu.....	84
20.2	Audio Menu	87
20.3	Presets Menu	88
20.4	Advanced Settings Menu.....	89
20.5	Information Menu.....	110
21.	Using the Touch Screen.....	113
	Planar UltraRes Web UI	114
22.	UltraRes Web UI Home Screen	116
23.	Admin.....	120
24.	Settings.....	123
25.	Setup	128
26.	WallDirector Cloud.....	131
26.1	Creating an Account	131
26.2	Equipment Management	132
	External Control	135
	Signal Compatibility.....	136
	Color Subsampling Report.....	140
	Power Consumption	141
	Specifications.....	142
	Dimensions.....	145
27.	URL122 Display.....	145
28.	Display and Included Wall Mount.....	146
29.	Display and Optional Rolling Cart.....	147
	Troubleshooting During Installation.....	149
30.	Error Codes	149
31.	Symptoms, Possible Causes and Solutions	150
31.1	Symptom: Display Doesn't Respond to External Control System	150
31.2	Symptom: Can't Get PC to Output 4K @ 24/30/60 Hz.....	150
31.3	Symptom: Can't Get PC to Output 4K @ 24/30/60 Hz.....	151
31.4	Symptom: HDCP 2.2 Sources Are Not Visible	151
31.5	Symptom: IR Isn't Working Properly.....	152
31.6	Column(s) Not Displaying an Image.....	152
31.7	Display Has Dark Lines in Bright Image or Is Not Smooth to the Touch	153
31.8	Touch Is Not Working	153
31.9	Erratic, Inaccurate, or Poor Touch Behavior.....	155
31.10	No Audio out of Right Speaker	155

Accessing Planar’s Technical Support Website..... 156
Regulatory Information..... 157

Introduction

The Planar® UltraRes™ L Series 122", Full HD resolution all-in-one LED display combines the ease-of-use and best-in-class processing of the Planar UltraRes family with award-winning Planar fine pixel pitch LED technology for meeting rooms and classrooms. The display comes with a wall mount and can be quickly assembled with only two people. It features on-board processing, audio, power from only one 110V cable, native multi-point touch and multiple inputs to support simultaneous viewing of up to four content sources. Optional rolling floor stand is available.

Features of the Planar UltraRes L Series 122" display include:

- 122" size
- Full HD resolution (1920 x 1080)
- Multi-source viewing
- 10-point touch interactivity

Caution: This manual is intended for use by qualified service persons and end users with experience configuring and installing AV equipment.

1. Safety Information

Before using the Planar UltraRes L Series, please read this manual thoroughly to help protect against damage to property, and to ensure personnel safety.

- Be sure to observe the following instructions.
- For your safety, be sure to observe ALL the warnings detailed in this manual.
- For installation or adjustment, please follow this manual's instructions, and refer all servicing to qualified service personnel.

2. Safety Precautions

- **If water is spilled or objects are dropped inside the display, remove the power plug from the outlet immediately.** Failure to do so may result in fire or electrical shock. Contact your dealer for inspection.
- **If the display is dropped or the chassis is damaged, remove the power plug from the outlet immediately.** Failure to do so may result in fire or electrical shock. Contact your dealer for inspection.

WARNING! Wall mounts must be secure.

- **If the display is hung on a wall, the wall must be strong enough to hold it.** Simply mounting it to wallboard or wall paneling won't be adequate or safe.

Caution:

- Displays should be mounted where viewers cannot insert small objects in the openings that will create hazards by contacting bare conductive parts.
- If the power cord or plug is damaged or becomes hot, turn off the main power switch of the display. Make sure the power plug has cooled down and remove the power plug from the outlet. If the display is still used in this condition, it may cause a fire or an electrical shock. Contact your dealer for a replacement.

2.1 Important Safety Instructions

1. Read these instructions.
2. Keep these instructions.
3. Heed all warnings.
4. Follow all instructions.
5. Do not use the display near water.
6. For cleaning the LED modules, refer to Planar Display Cleaning Guidelines found at <https://www.planar.com/support/display-cleaning/>
7. Do not install near any heat sources such as radiators, heat registers, stoves or other apparatus (including amplifiers) that produce heat.
8. Do not defeat the safety purpose of the polarized or grounding type plug. A polarized plug has two blades with one wider than the other. A grounding type plug has two blades and a third grounding prong. The wide blade or the third prong is provided for your safety. When the provided plug does not fit into your outlet, consult an electrician for the replacement of the obsolete outlet.
9. Protect the power cord from being walked on or pinched, particularly at plugs, convenience receptacles and the point where they exit from any equipment.
10. Only use the attachments/accessories specified by the manufacturer.
11. Unplug all displays during lightning storms or when unused for long periods of time.
12. In instances where a power surge has occurred and a display no longer has an image, the display power will need to be reset.
13. You must follow all National Electrical Code regulations. In addition, be aware of local codes and ordinances when installing your system.
14. Refer all servicing to qualified service personnel. Servicing is required when any of the displays have been damaged in any way. For example, if the AC power cord or plug is damaged, liquid has been spilled or objects have fallen into a display, the displays have been exposed to rain or moisture, do not operate normally or have been dropped.
15. Keep the packing material in case the equipment should ever need to be shipped.
16. Mounts must be secure. The structure must be strong enough to hold displays brackets, cables and accessories. Seismic engineers should be consulted in areas prone to earthquakes.
17. **Caution:** There is a risk of explosion if the battery is replaced with incorrect type. Dispose of used batteries according to local regulations.
18. The LEDs mounted on the front surface of the Planar UltraRes L Series can be damaged by contact with fingernails, rings and other hard items.
19. Any changes or modifications to the display not expressly approved by Planar could void the user's authority to operate this equipment.

2.2 Informations sur la sécurité

Avant d'utiliser le Série Planar UltraRes L, veuillez lire attentivement ce manuel pour éviter tout dommage matériel et assurer la sécurité du personnel.

- Assurez-vous de respecter les instructions suivantes.
- Pour votre sécurité, veuillez respecter TOUS les avertissements détaillés dans ce manuel.
- Pour l'installation ou le réglage, suivez les instructions de ce manuel et confiez l'entretien à un personnel qualifié.

2.3 Précautions de sécurité

- **Si de l'eau est renversée ou si des objets sont tombés à l'intérieur de l'écran, débranchez immédiatement la fiche d'alimentation de la prise.** Le non-respect de cette consigne peut entraîner un incendie ou une électrocution. Contactez votre revendeur pour qu'il procède à une inspection.
- **Si l'écran est tombé ou si le châssis est endommagé, débranchez immédiatement la fiche d'alimentation de la prise.** Le non-respect de cette consigne peut entraîner un incendie ou une électrocution. Contactez votre revendeur pour qu'il procède à une inspection.

AVERTISSEMENT! Les supports muraux doivent être sécurisés.

- **Si l'écran est accroché à un mur, celui-ci doit être suffisamment solide pour le supporter.** Un simple montage sur une plaque de plâtre ou un panneau mural n'est ni suffisant ni sécuritaire.

Attention : Pour le modèle non tactile :

- Le polariseur avant du modèle URL non tactile est souple et peut être rayé par des objets pointus.
- Une légère pression sur l'écran LED du modèle URW non tactile entraînera une distorsion de l'image. Une pression plus forte causera des dommages permanents.

Attention : Pour tous les modèles URL:

- Les écrans doivent être montés de manière à ce que les spectateurs ne puissent pas insérer de petits objets dans les ouvertures, ce qui créerait des dangers en touchant des pièces conductrices nues.
- Si le cordon d'alimentation ou la fiche est endommagé(e) ou devient chaud(e), éteignez l'interrupteur principal de l'écran. Assurez-vous que la fiche d'alimentation a refroidi et retirez-la de la prise de courant. Si vous continuez à utiliser l'écran dans cet état, vous risquez de provoquer un incendie ou une électrocution. Contactez votre revendeur pour un remplacement.

2.4 Consignes de sécurité importantes

1. Lisez ces consignes.
2. Conservez ces consignes.
3. Tenez compte de tous les avertissements.
4. Suivez toutes les consignes.
5. N'utilisez pas l'écran près de l'eau.
6. Nettoyez les écrans LED avec un nettoyant ou des lingettes prévus pour ce type d'appareil.
7. N'installez pas l'appareil près de sources de chaleur telles que radiateurs, bouches de chaleur, poêles ou autres appareils (y compris les amplificateurs) qui produisent de la chaleur.
8. Ne neutralisez pas le dispositif de sécurité de la fiche polarisée ou de mise à la terre. Une fiche polarisée possède deux lames, l'une plus large que l'autre. Une fiche de mise à la terre a deux lames et une troisième broche de mise à la terre. La lame large ou la troisième broche est prévue pour votre sécurité. Si la fiche fournie ne rentre pas dans votre prise, consultez un électricien pour remplacer la prise obsolète.
9. Protégez le cordon d'alimentation contre les piétinements et les pincements, en particulier au niveau des fiches, des prises de courant et du point de sortie de tout écran LED grand format de Planar.
10. Utilisez uniquement les accessoires spécifiés par le fabricant.
11. Débranchez tous les écrans pendant les orages ou lorsque vous ne les utilisez pas pendant de longues périodes.
12. Dans les cas où une surtension s'est produite et qu'un écran n'a plus d'image, il faudra réinitialiser l'alimentation de l'écran.
13. Vous devez respecter toutes les règles du Code national de l'électricité. De plus, tenez compte des codes et des règlements locaux lors de l'installation de votre système.
14. Confiez toute réparation à un personnel qualifié. Une réparation est nécessaire lorsque l'un des écrans a été endommagé de quelque manière que ce soit. Par exemple, si le cordon ou la fiche d'alimentation CA est endommagé(e), si du liquide a été renversé ou si des objets sont tombés dans un écran, si les écrans ont été exposés à la pluie ou à l'humidité, s'ils ne fonctionnent pas normalement ou s'ils ont été échappés.
15. Conservez le matériel d'emballage au cas où l'équipement devrait être expédié.
16. Les supports muraux doivent être sécurisés. Le mur doit être suffisamment solide pour supporter les supports, les câbles et les accessoires des écrans. Des ingénieurs sismiques devraient être consultés dans les zones sujettes aux tremblements de terre.
17. **Attention** : Il existe un risque d'explosion si la pile est remplacée par un type incorrect. Éliminez les piles usagées conformément aux règlements locaux.

3. Recommended Usage

In order to get the most out of the Planar UltraRes L Series, use the following recommended guidelines to optimize the display.

Note: Planar UltraRes L Series is designed for use only with Planar’s optional rolling floor stand, or installed with the provided fixed wall mount, and is for indoor use only.

Note: Non-uniform, non-black static content displayed on LED displays can cause uneven decay of performance, commonly referred to as “burn in.” Although direct view LED is far more resistant to burn in, extended use of static images can cause uneven image performance. The higher the brightness, the quicker this can manifest. Burn-in causes the screen to retain an image, with little or no way to correct. Under normal use, an LED will not experience burn-in, nor will it retain images in any way.

Normal use of the display is defined as displaying continuously changing video patterns or images.

3.1 Warranty Coverage

The 122” URL122 is warranted for **24 x 7** usage.

Planar recommends turning off the power for **4 hours per day** for optimal performance.

For complete warranty details, please visit <http://www.planar.com/warranty>.

3.2 Important Waste Disposal Information

Please recycle or dispose of all electronic waste in accordance with local, state, and federal laws. Additional resources can be found online at <http://www.planar.com/about/green/>.

The crossed-out wheelee bin symbol is to notify consumers in areas subject to Waste Electrical and Electronic Equipment (WEEE) Directive 2012/19/EU that the product was placed on the market after August 13, 2005 and must not be disposed of with other waste. Separate collection and recycling of electronic waste at the time of disposal ensures that it is recycled in a manner that minimizes impacts to human health and the environment. For more information about the proper disposal of electronic waste, please contact your local authority, your household waste disposal service, or the seller from whom you purchased the product.



3.3 Normal Usage Guidelines

Normal use of the display is defined as operating in the open air to prevent heat buildup, and without direct or indirect heat sources such as lighting fixtures, heating ducts, or direct sunlight that can cause the displays to experience high operating temperatures. For all displays, do not block fans or ventilation openings. If the display will be installed in a recessed area with an enclosure, ensure adequate openings are applied for proper air flow and ventilation.

It is up to the installer to ensure that display placement is changed, thermal shielding is provided and/or additional ventilation is provided to keep the display within its nominal operating parameters. Maximum ambient operating temperatures for the Planar UltraRes L Series are:

- 0-40°C at up to 1000 meters
- 0-35°C at up to 2000 meters
- 0-30°C at up to 3000 meters



Cooling Requirements





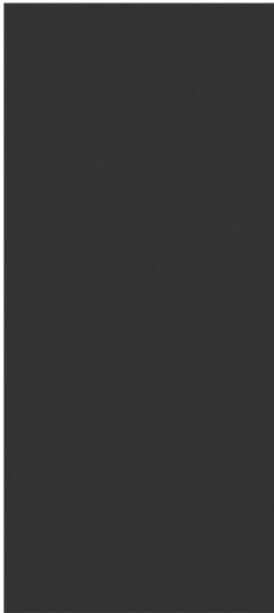

For optimal performance, active cooling by the installer should be planned for when the ambient temperature anywhere in the wall is predicted to be above the specified ambient temperature for the display.

Unpacking and Checking Accessories

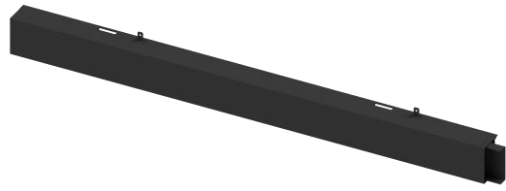







The URL122 comes in one convenient crate. To open, use 14mm (9/16) nut drivers or wrenches to remove the bolt assemblies from the end of the crate. The end of the crate may be lifted from the crate and the underlying protective wrap can be removed to expose the cartons containing the various parts of the product.



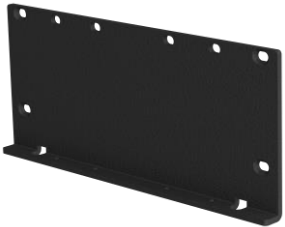



4. Package Contents

Part	Description	Number	Picture
Left mount bar	Provides left structure for LED columns to wall or rolling stand.	2	
Right mount bar	Provides right structure for LED columns to wall or rolling stand.	2	
LED columns	Provides mounting structure for LED modules and precision surfaces and features for alignment, labeled 1 through 4. Note: All columns are mechanically or electrically different and are installed in order. The installation positions cannot be swapped.	4	

Part	Description	Number	Picture
Left electronics	Provides electronic functions for the display.	1	
Right electronics	Provide electronic functions for the display.	1	
Left front cover, comes attached to above left electronics	Provides front cover for left electronics and holds screen bottom touch sensor electronics.	1	
Right front cover, comes attached to above right electronics	Provides front cover for right electronics and holds display bottom touch sensor electronics.	1	
Left side trim	Provide display trim on left side and holds screen left side touch sensor electronics.	1	
Right side trim	Provide display trim on right side and holds screen right side touch sensor electronics.	1	
Top left trim	Provide display trim on top left side and holds display top left touch sensor electronics.	1	
Top right trim	Provide display trim on top right side and holds display top right touch sensor electronics.	1	

5. Accessory Kit

Part	Description	Number	Picture
Jack screw bracket	Provide column position adjustment. Attaches to mounting bar and positions jack screw mounting threads.	12	
Column alignment plate	Provide vertical adjustment for installed columns.	5	
Front cover	Provides aesthetic front cover for electronics box seam.	1	
Front cover bracket	Provides structural strength for electronics box attachment.	1	
AC power cord	Provide AC connection to the display (4.5m).	1	
IR sensor	Used to receive signals from remote control (3m).	1	
HDMI® cable	Provide audio and video input to the display (3m).	1	
USB cable	Connects to a PC for touch functionality and serial commands (3m).	1	
Remote control	Used to control the display.	1	







Part	Description	Number	Picture
Battery	AAA for remote.	2	
Gloves	Used to handle columns and LED modules.	2 pairs	
Quick Start Guide		1	
Module removal tool/charger	Removes LED modules of the display.	1	
Signal flex cable	Provides signal between LED columns.	5	
Tab screw	Attaches electronics assembly to the bottom of the LED columns and attaches handles to columns, M4x8.	10	
Bracket screws	Bracket to electronics assembly, M3x6 panhead screw w/ lock and flat washer.	12	
Trim screw	Attaches top trim to side trim; M3x20 flathead screw.	4	



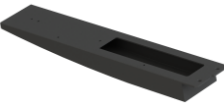
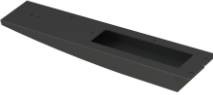

Part	Description	Number	Picture
Trim, front covers, front cover, front cover bracket, bracket, front covers screw	Attaches side trim to electronics, bracket to electronics, front cover bracket to front covers, front cover to front cover bracket; M3x6 flathead screw.	55	
Column alignment plate screw	Attaches column alignment plate to top of columns; M4x10 flathead screw.	25	
Mount bar, column, electronics assemblies screw	Attaches mount bars together, column 4 to column 5, and base of columns to electronics assembly; M5x10 panhead screw w/ lock and flat washer	12	
Handles	Attaches to column for optional installation.	2	
Tool Kit	4M hex ball end wrench, 2X magnet adjustment tool, and #1 Phillips screwdriver	1 set	
Touch Flex Cables	Male to Male and Female to Male to replace damaged touch sensor connections.	2 Each Type	
Spare LED Modules	Extra LED modules for replacement.	4	

6. Optional Accessories

Part	Description	Number	Picture
Spare LED Modules	Extra LED modules for replacement.	Quantity as ordered	

7. Optional Rolling Stand Crate

Part	Description	Number	Picture
Vertical column assembly	Provides the vertical structure to mount the main beams and provides rollers for the stand.	2	
Main support beam	Provides a horizontal structure between the 2 vertical column assemblies and provides an attachment surface for the mount bars.	2	
Left wing	Provides an extension of the main beams on the left side.	2	
Right wing	Provides an extension of the main beams on the right side.	2	
Main beam, wing washers	Used with M8x12 stand screws, M8 flat washer.	8	
Main beam, wing screws	Attaches vertical column to main beams and wings, M8x12 socket head screw.	8	
Main beam, wing screws	Attaches vertical column to main beams and wings, M4x10 flat head screw.	16	

Part	Description	Number	Picture
Mount bar screws	Attaches mount bars to rolling floor stand.	12	
Mount bar washers	Attaches mount bars to rolling floor stand.	12	
Caster wrench	Tool for tightening the casters to the floor stand.	1	
5mm hex key	Tool for attaching wall mount to stand.	1	
6mm hex key	Tool for attaching the wings to the stand.	1	

8. Planar UltraRes L Series – Standard Inputs

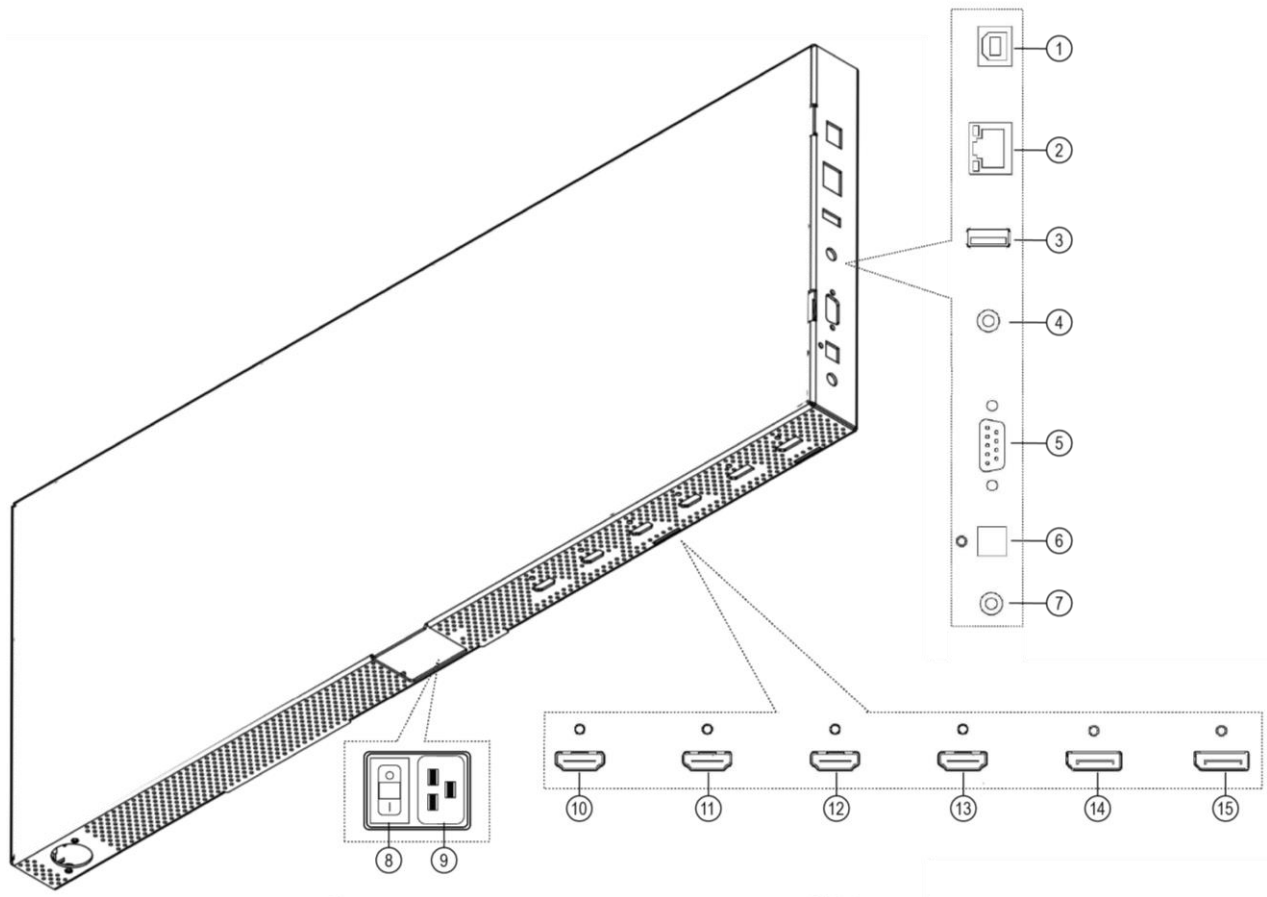

URL122	Description
1	USB-B: Touch
2	LAN
3	USB-A: Service
4	IR: 3.5mm TRS (female)
5	RS232: DB9 (female)
6	SPDIF Audio Out
7	Line Audio Out: 3.5mm TRS (female)
8	AC ON/OFF
9	AC IN: IEC C20
10	HDMI 1: HDMI, 4K/60Hz, HDCP 2.2
11	HDMI 2: HDMI, 4K/60Hz, HDCP 2.2
12	HDMI 3: HDMI, 4K/30Hz, HDCP 1.4
13	HDMI 4: HDMI, 4K/30Hz, HDCP 1.4
14	DP IN: DisplayPort In, 4K/60Hz
15	DP OUT: DisplayPort Out

Note: Only one HDCP 2.2 source can be displayed at a time. If HDMI 1 and HDMI 2 are both being shown on the display at the same time, only HDMI 1 will support HDCP 2.2 content.

Note: DP-OUT can only transmit the content from DP IN. It cannot transmit the content from any HDMI Input.

Installing the Display

Sections 9 and 10 explain how to install the display. We suggest reading them both before attempting to install the unit.

9. Before Beginning

Make sure all the items in the following lists are present before unpacking and installing the display(s).

9.1 Tools/Equipment List

Depending on the installation, one or more of the following items may be needed:

- 4' or longer magnetic straight edge/bubble level or laser level
- Tape and marker or pencil
- Video source
- Ladders/lift
- Back brace
- Mounting hardware
- Shims

9.2 Other Things That May Be Needed

- At least two strong people to help lift equipment into place
- Charge the battery on the module removal tool from the accessory kit

9.3 Plan the Installation

Have a detailed plan of how the equipment is to be configured. The plan should include calculations for the following:

- Power maximums referenced below:

Model	Max Current @ 120VAC
URL122-MFT	11.2A

- Cable runs
- Ventilation and cooling requirements
- If hanging display on a wall, location of studs in the wall
- If the display is a touch model, it is important that the touch frame is not used to lift or support the display or touch performance may be compromised.

9.4 Prepare the Installation Location

Prepare the area where the unit will be installed. If custom enclosures are part of the installation, they must be fully designed to accommodate the installation of the displays, the installed units, and ventilation and cooling requirements.

If the installation area includes a lot of construction or dust, it is **highly recommended** that the LED surface be protected from debris during construction and the display is cleaned afterwards.

9.5 Cable Length Recommendations

Cable length performance may vary between different cables and sources. The recommended maximum cable lengths are as follows:

HDMI

- 4K @ 50/60Hz: 5m (15 ft) maximum
- 4K @ 24/25/30Hz: 15m (50 ft) maximum
- 1080p @ 60Hz and lower resolutions: 20m (65 ft) maximum

DisplayPort

- DP 1.2: 3m (10 ft) maximum
- DP 1.1: 5m (15 ft) maximum

10. Assembly

10.1 Assembling Mount Bars

1. Locate the left and right mount bar and place them on a flat surface as shown. Slide together engaging alignment pins.

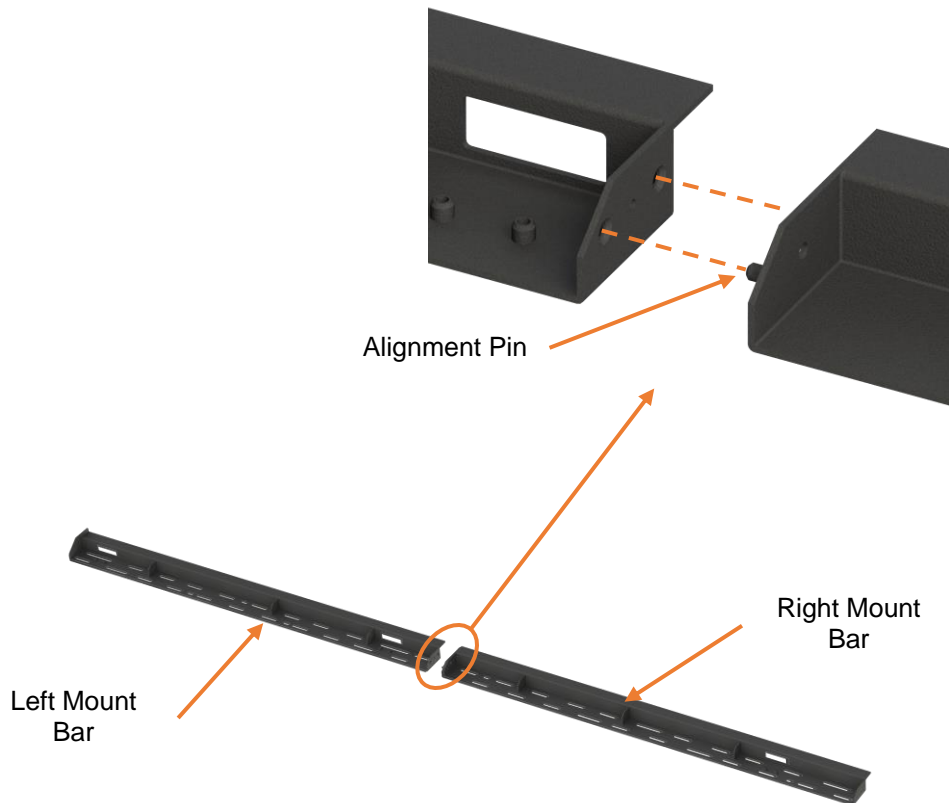

2. Install (1X) M5 x10 PHMS w/ lock and flat washer to secure connection between the two mount bars.

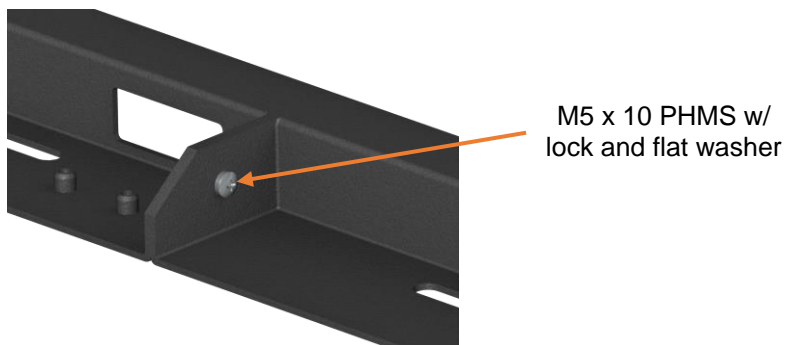

3. Repeat procedures 1-2 above with the second set of mount parts.

10.2 Assembling Rolling Floor Stand

If mounting to a structure skip to the “Preparing the Wall for Wall Mounting” section on page 32.

1. The rolling floor stand can hold the display at two heights, approximately 2235mm (88.0”) or 2335mm (91.9”) from the ground. The following procedures show the lower rolling floor stand assembly. If mounting the desired height of 2335mm (91.9”), use the hole patterns labeled with 800 instead of 700 where appropriate.

Note: The rolling floor stand has adjustable casters to achieve a level display. When assembling, be sure they are fully tightened to the stand. When adjusting, the maximum distance of adjustment from fully tightened of any wheel should be about 0.20" (5mm) or approximately 3 full rotations of the adjustment wrench.

Caution:

- When moving the display between locations, it is highly recommended to avoid sharp changes in the rolling surface height and soft surfaces like plush carpet.
- Do not use excessive force to move the display. When moving a display, grip and apply force to the stand, not the display.
- It is suggested to move the unit on the floor stand over long distances with the narrow edge leading to ease movement.

2. Position the two vertical column assemblies as shown on a flat surface. Noting the orientation of threaded holes along the support beams lower face, place the ends of the first support beam over the lower hole pattern on the top of the vertical columns engaging the alignment pins between the parts as shown.

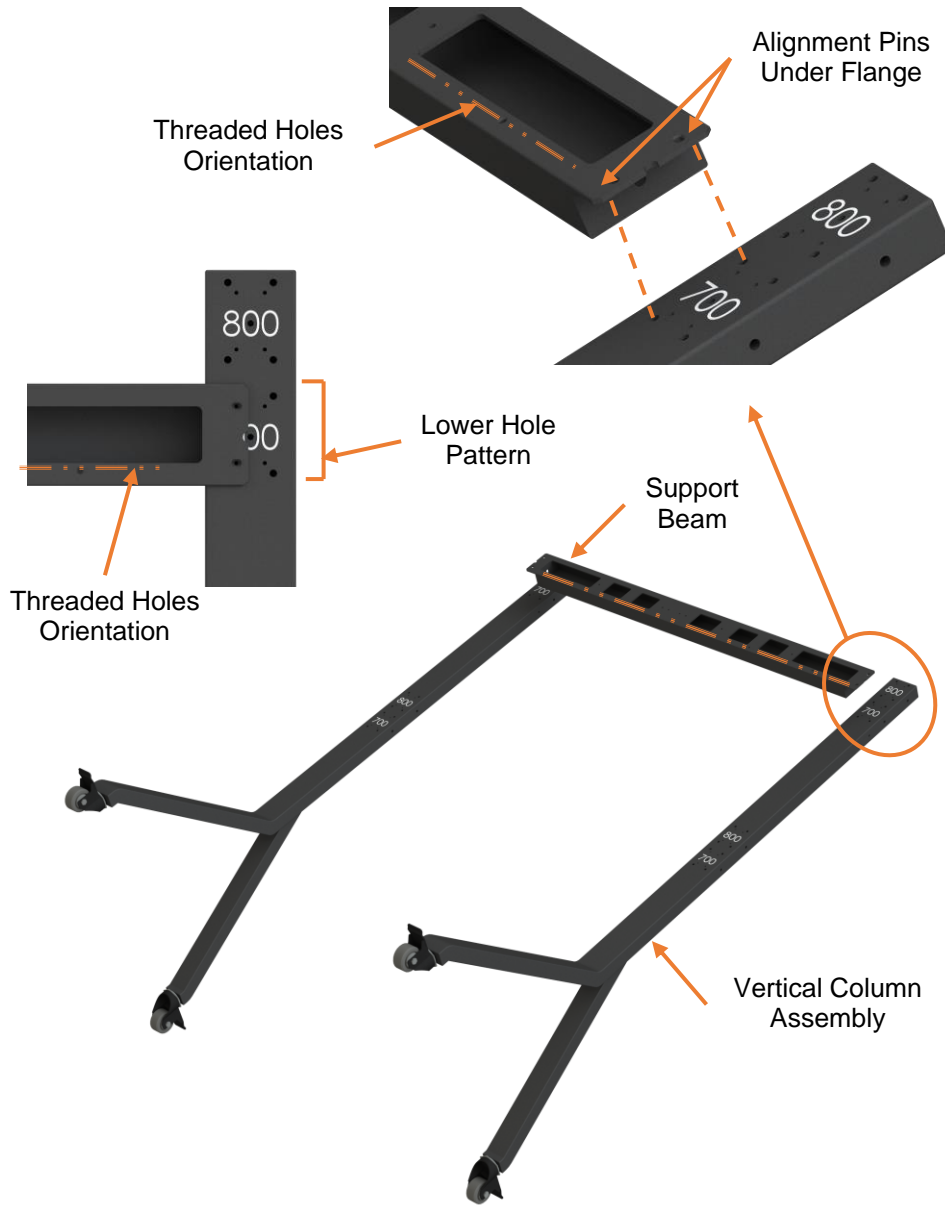

3. Noting the orientation of threaded holes along the support beams lower face, place the ends of the second support beam over the lower hole pattern in the middle of the vertical columns engaging alignment pins between the parts as shown.

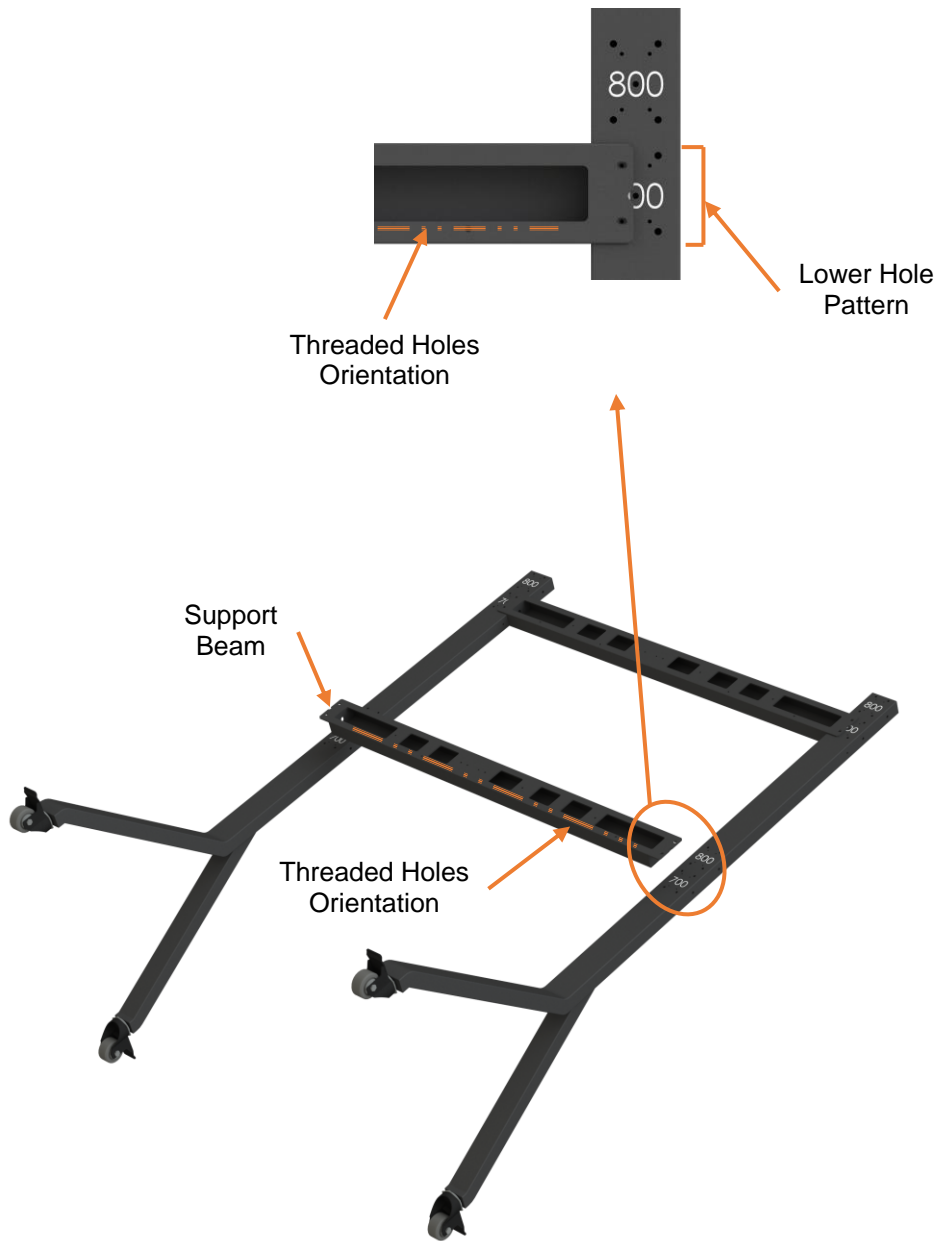

4. Noting the orientation of threaded holes along the left wings lower face, place the end of the left wing over the lower hole pattern on the top of the vertical column engaging the alignment pins between the parts as shown.

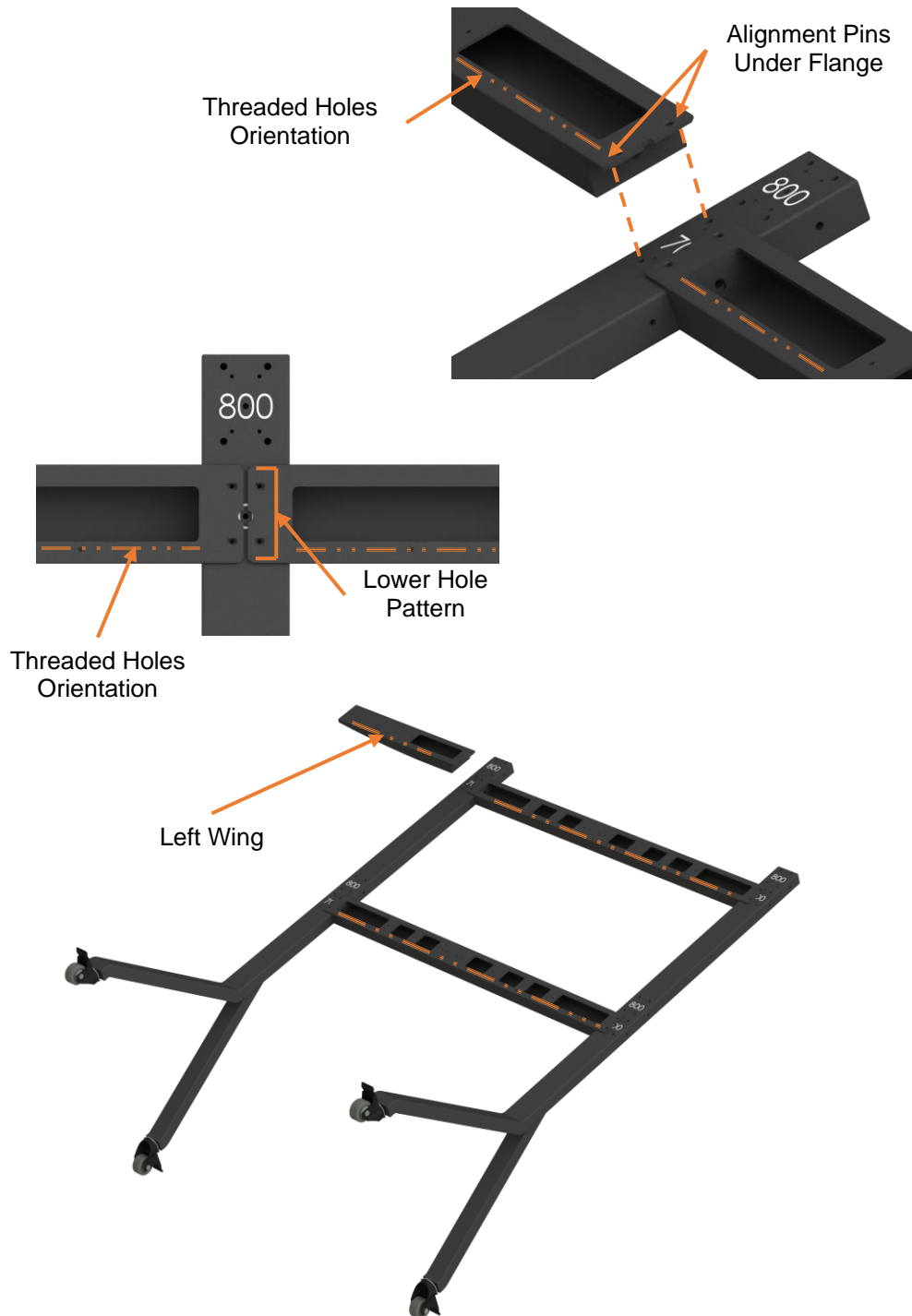

5. Noting the orientation of threaded holes along the left wings lower face, place the end of the second left wing over the lower hole pattern in the middle of the vertical column as shown above.

6. Noting the orientation of threaded holes along the right wings lower face, place the end of the right wing over the lower hole pattern on the top of the vertical column engaging the alignment pins between the parts as shown.

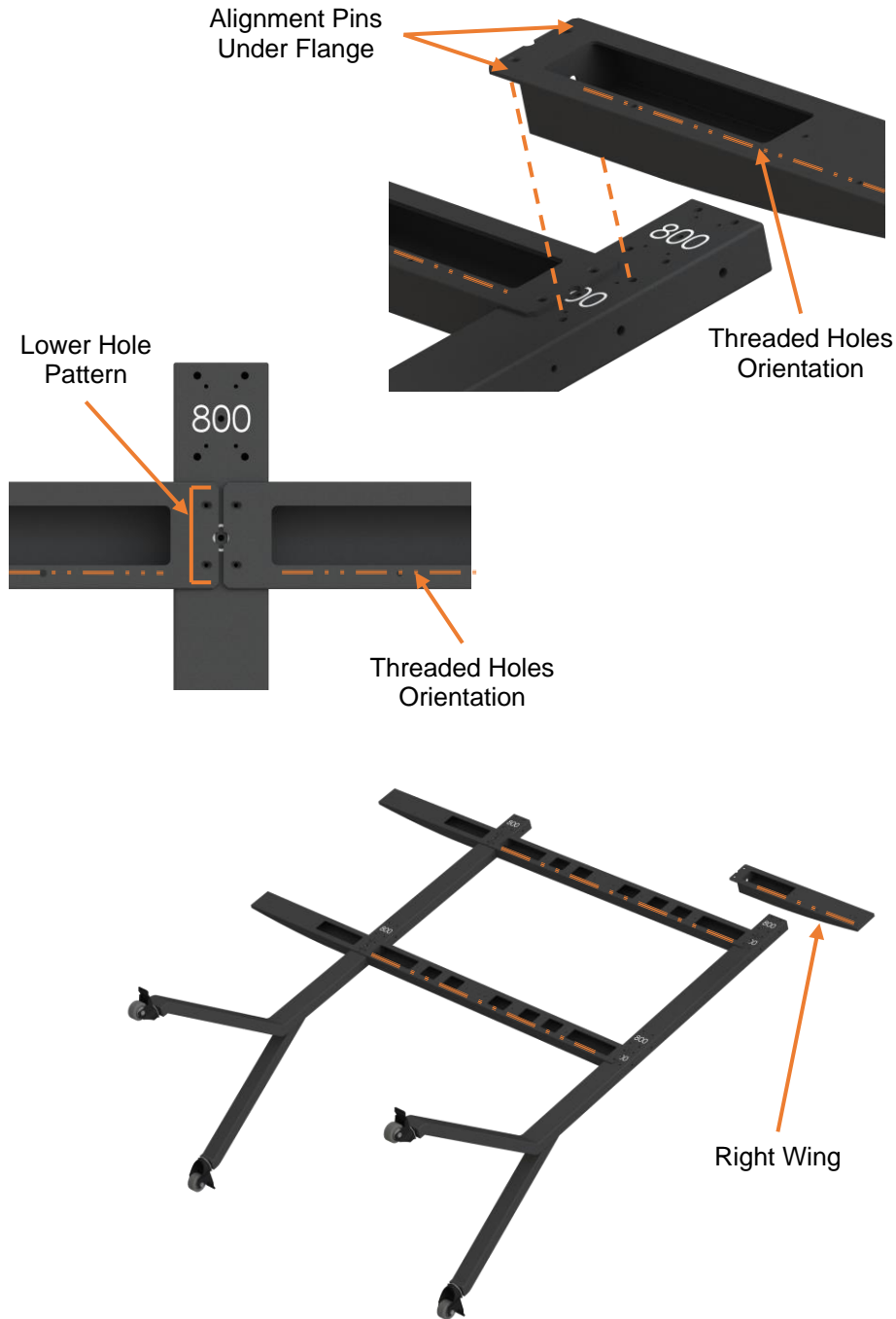

7. Noting the orientation of threaded holes along the right wings lower face, place the end of the second right wing over the lower hole pattern in the middle the vertical column as shown above.

8. Install (2X) M4 X 10 FHMS and (1X) M8 x 12 SHCS w/ M8 flat washer. Repeat screw installation on the three other support beam connections as shown.

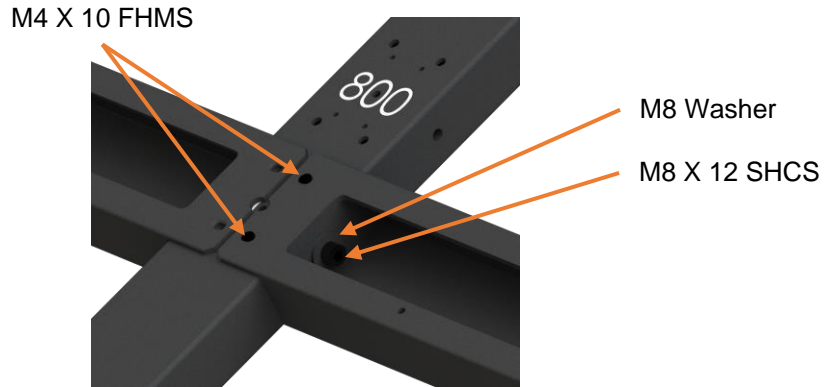

9. Install (2X) M4 X 10 FHMS and (1X) M8 x 12 SHCS w/ M8 flat washer. Repeat screw installation on the three other wing connections as shown.

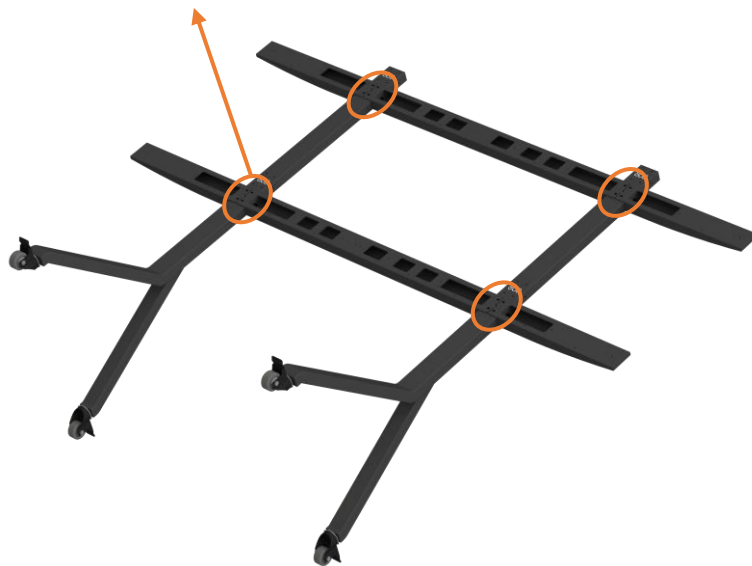
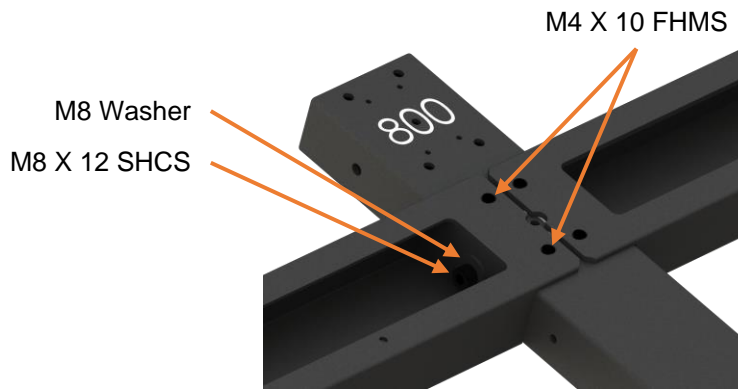

10. Stand assembly is now complete.

10.3 Installing Mount Bars to Rolling Floor Stand

1. Position the top mount bar assembly on the stand's alignment pins on the upper horizontal beam as shown.



2. Installing (6X) M6 X 20 SHCS w/ lock and flat washer plus large M6 flat washer in locations shown.



3. Repeat assembly steps for bottom mount bar placing on alignment pins and installing (6X) M6 X 20 SHCS w/ lock and flat washer plus large M6 flat washer as shown.



10.4 Preparing the Wall for Wall Mounting

1. Make sure that the wall and the mounting hardware are capable of supporting the weight of the entire display configuration.

Check the “Specifications” section on page 142 for component weights.

2. A wall/structure that is flat within $\pm 3\text{mm}$ ($1/8''$) and plumb is highly recommended as a starting point.
3. Plan and route remote cabling prior to mount installation. When installing on a solid structure, consider where the mounts will be and plan to have cable ingress between the mounts near the left side of the display.

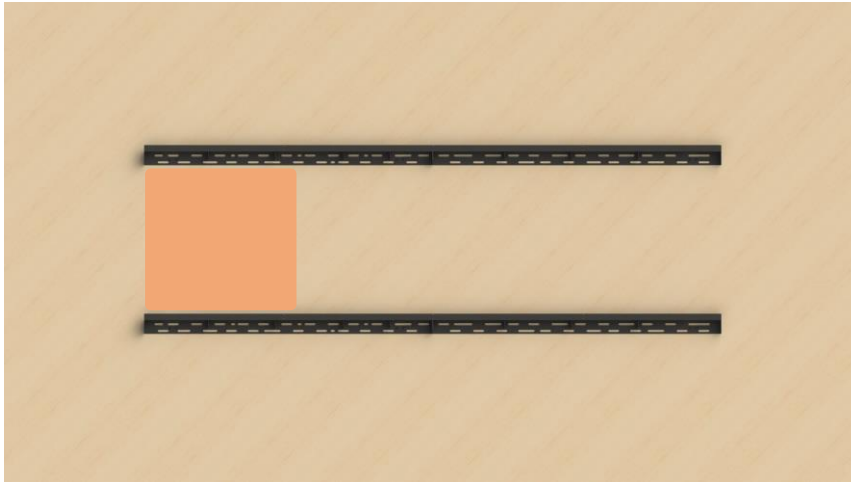

4. Determine and mark a vertical and horizontal line of the center of the image of the unit. For mount location verification, it is optional to continue the line or mark the left and right most edge of the image as well as the top.

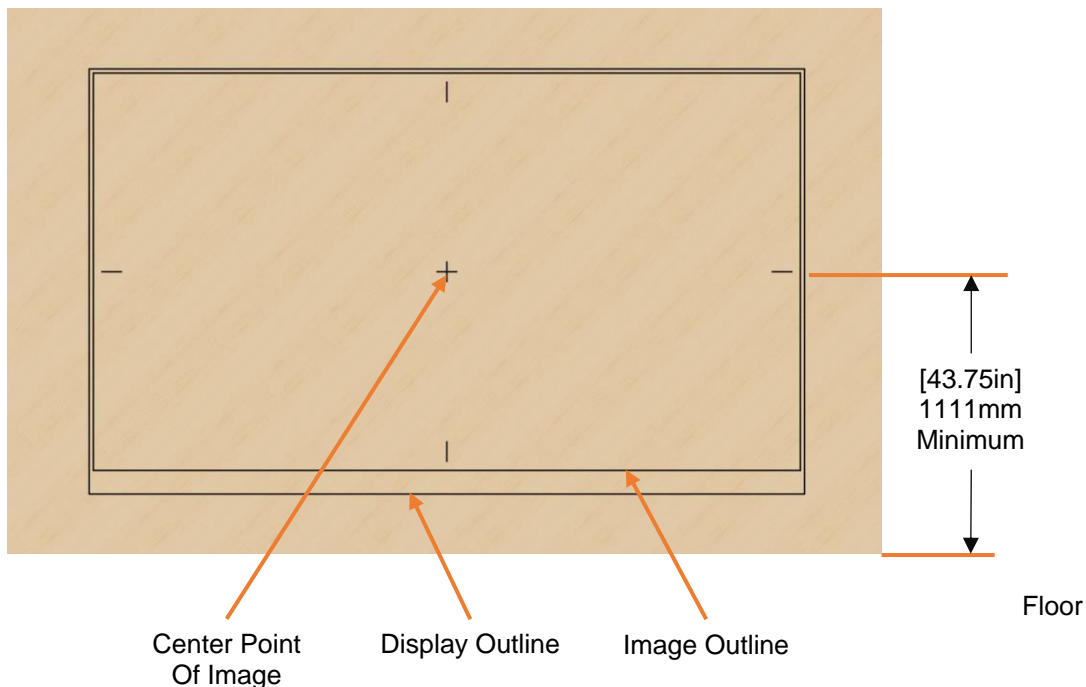

10.5 Installing the Mount Bars on the Wall

1. Using the dimension and positioning mount bar centerline as shown, secure left end of top mount bar assembly with attachment hardware (not included) into a wall stud. Use a level to ensure the mount bar assembly is leveled horizontally. Secure mount bar assembly to the wall studs as available with the mounting slot patterns.

Note: Use sufficient quantity of hardware in the top mount bar to keep the display from pulling the mount away from the structure.

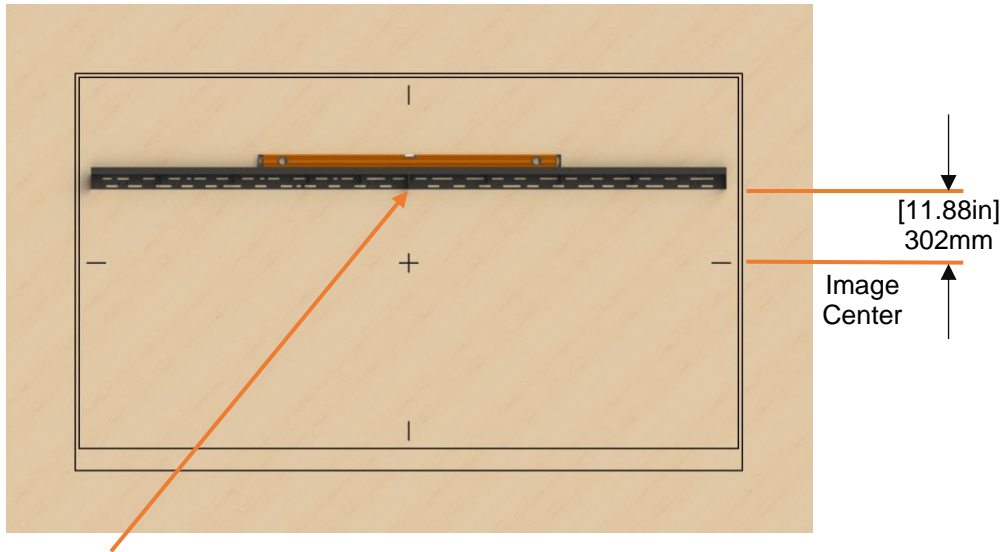

Mount bar centerline

2. Install bottom mount bar using the dimension from the top mount bar. Use a level to ensure the mount bar assembly is leveled horizontally. Use a level to ensure the left ends of the mount bars are plumb vertically. Secure the bottom mount bar assembly to the wall studs as available with the mounting slot patterns.

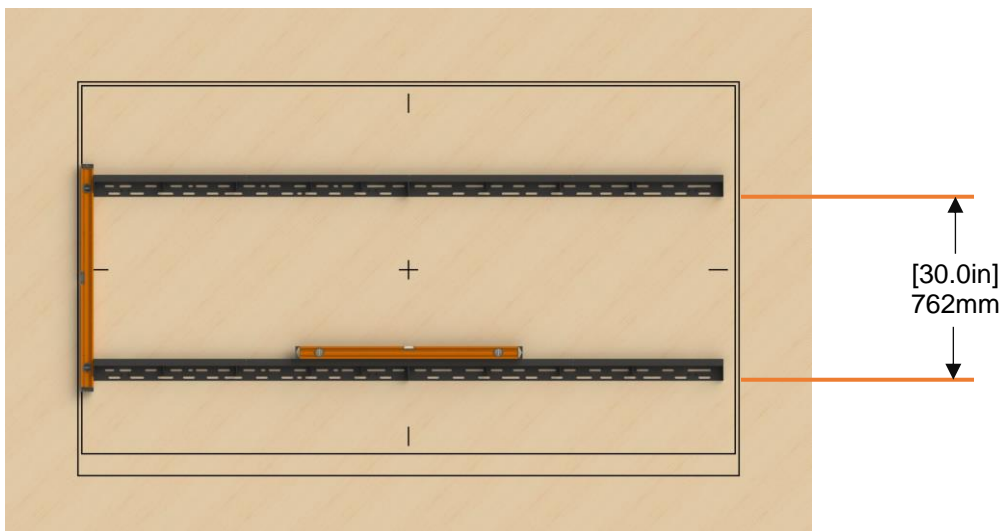

10.6 Installing LED Columns

1. Remove column 1 from packaging box along with any additional protective wrap. If installing into a recess, remove the column edge guards; otherwise, leave column edge guards attached.
2. Wearing the provided gloves, hang column 1 near the left edge of the mount bars, ensuring the upper and lower hanger brackets of the column are hooked on the mount bar flanges as shown.

Note: The mount bars have flanges along the length that can limit columns from being slid left. Be sure the placement of the column is far enough left that it can be slid over to the left as far as possible.

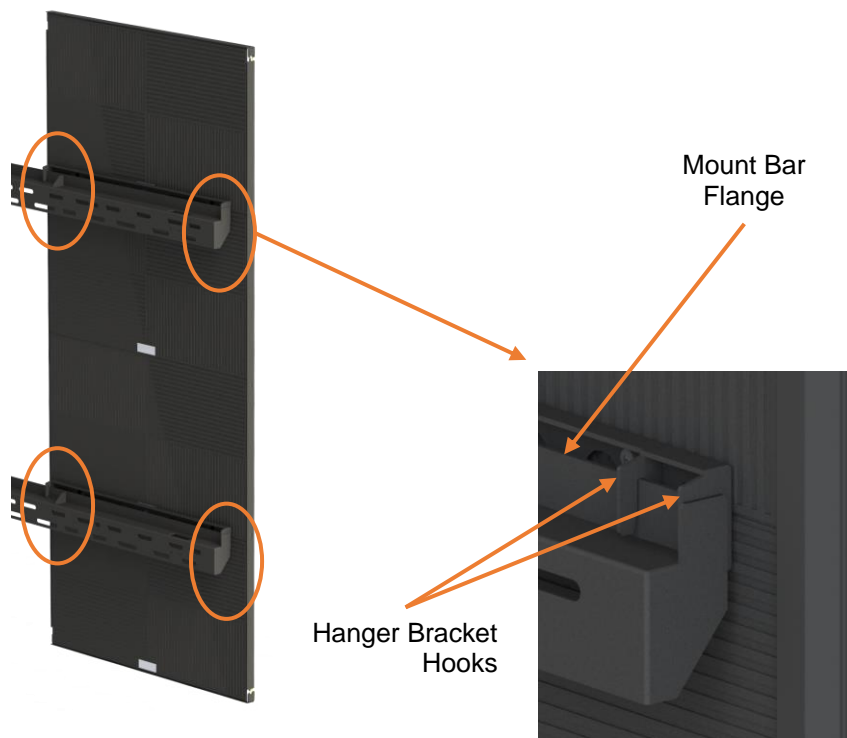

3. Slide the column all the way to the left until the hanger brackets are against the mount bar end plates.

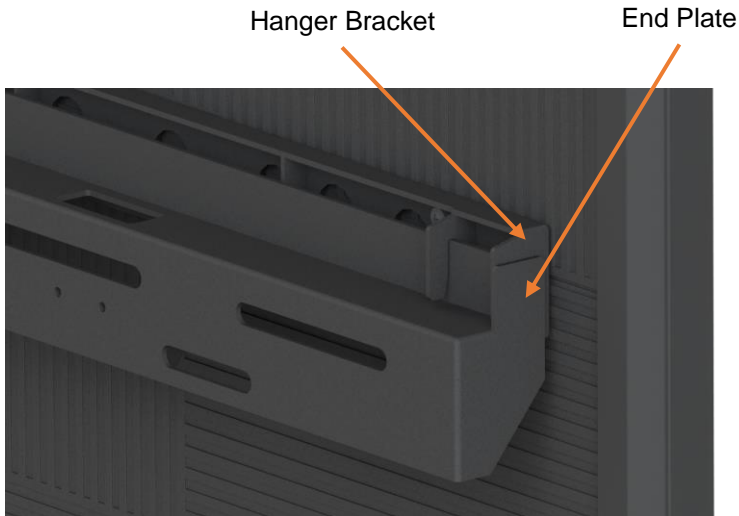

4. Remove the flathead screws securing a column edge guard. Carefully remove the guard without contacting the LEDs. Repeat for the 3 other edge guards.

Note: The outer edges of the columns have magnets that may hold the guards in place. These may require more force to remove.

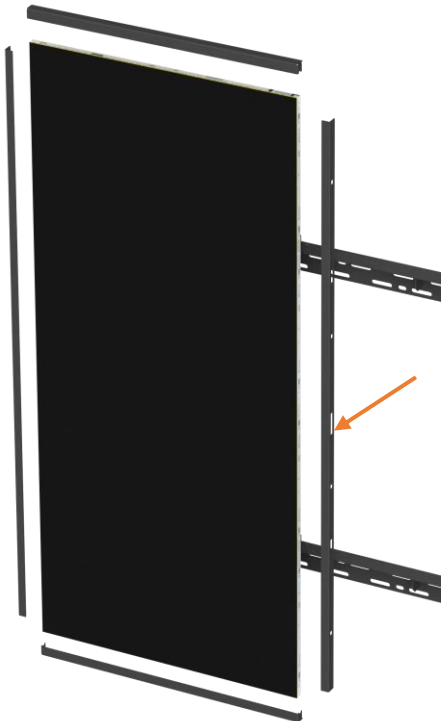

5. Install column jack screw brackets with (2X) M3 X 6 FHMS to both the upper and lower mount bars.

Note: The jack screw may need to be partially unscrewed to install on the mount bars.

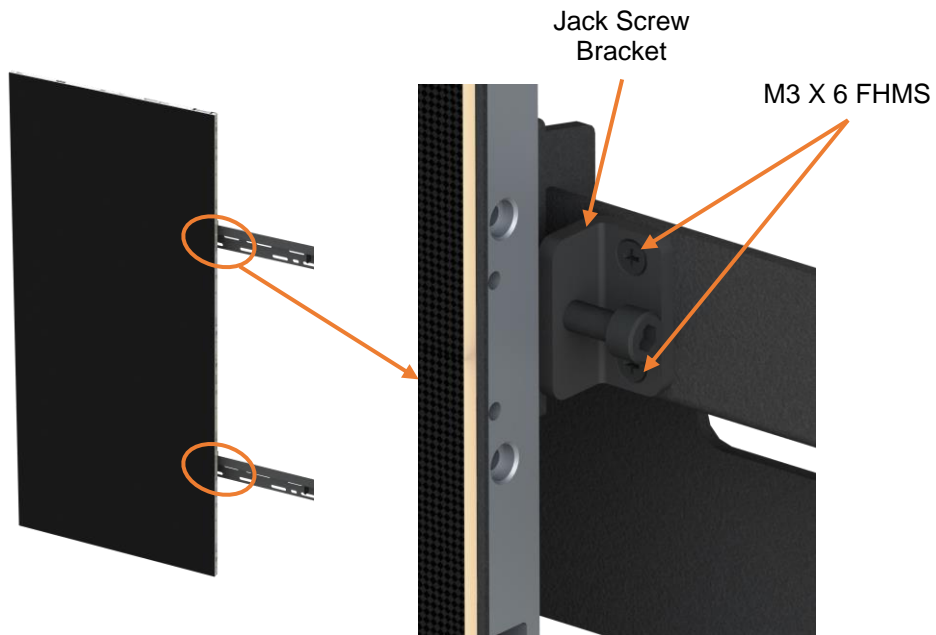

6. Tighten each jack screw against the columns hanging bracket to push and hold column against mount bar endplates. Verify plumb of the column and loosen or tighten jack screws as needed.

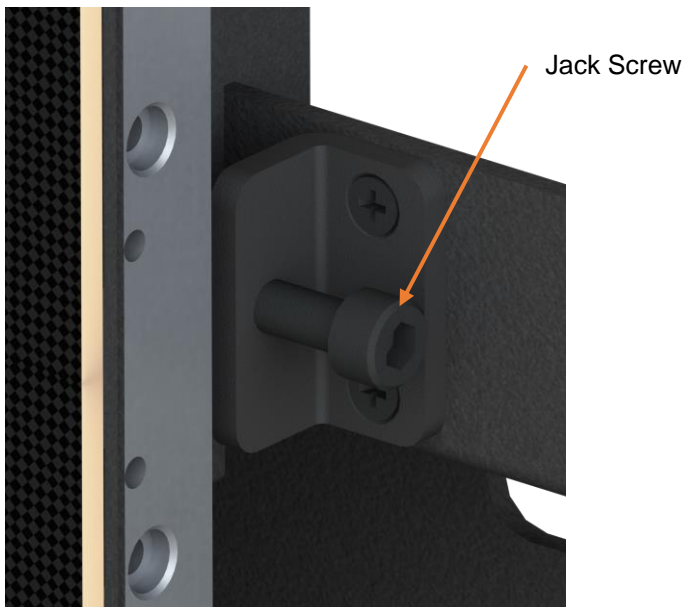

7. Remove column 2 from the packaging. After removing column 2's left edge guard, hang the column on the mount bars. Remove the remaining edge guards and gently slide to the left against column 1. Attach the jack screw brackets as in step 5 and adjust the jack screws creating a thin vertical gap between the columns. The gap should be small enough to perform the next step. Do not over tighten the jack screws; it may prevent following alignment steps.

Note: Having a gap that is not even the entire length of the column may result in having to repeat step 8. The pixel spacing between columns should look like the pixel spacing within a module for best results.

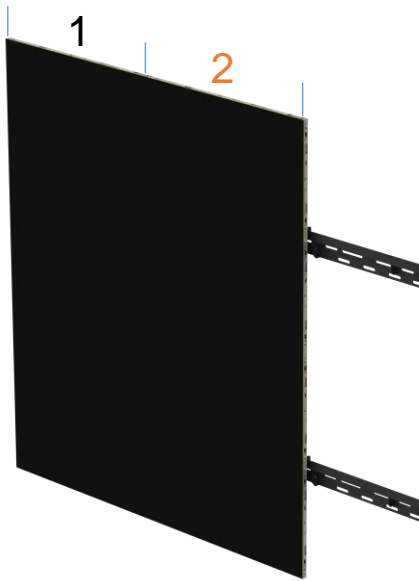

8. To vertically align columns, use the column alignment plates. When two columns are installed next to each other determine which column needs to be raised to correct alignment. Place the thick side of the column alignment plate on the column to remain fixed in place and install a M4 X 10 FHMS screw. Install another M4 X 10 FHMS screw through the thin side of the column alignment plate into the other column and tighten until the pixels are in horizontal alignment with the fixed column. It may be beneficial to help raise a column by lifting from the bottom as the screw is being tightened.

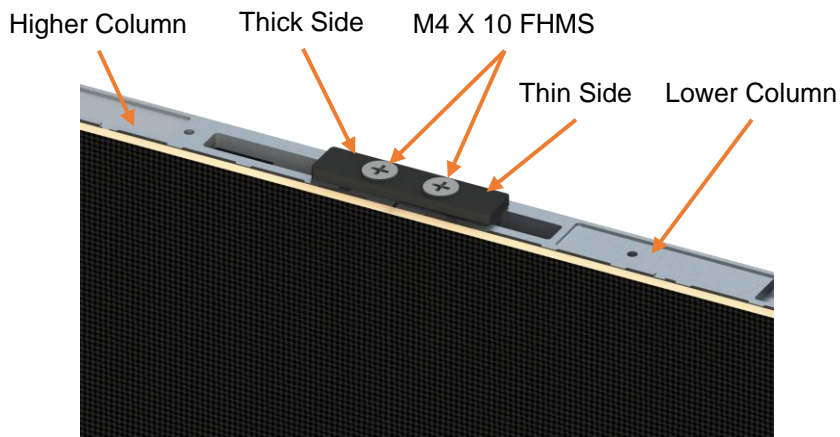

9. Adjust the jack screws installed in step 7 to create an even vertical spacing. The pixel spacing between columns should look like the pixel spacing within a module for best results. After adjusting the jack screws, check the vertical alignment done in step 8 and correct if needed.
10. Repeat steps 7 through 9 for column 3.

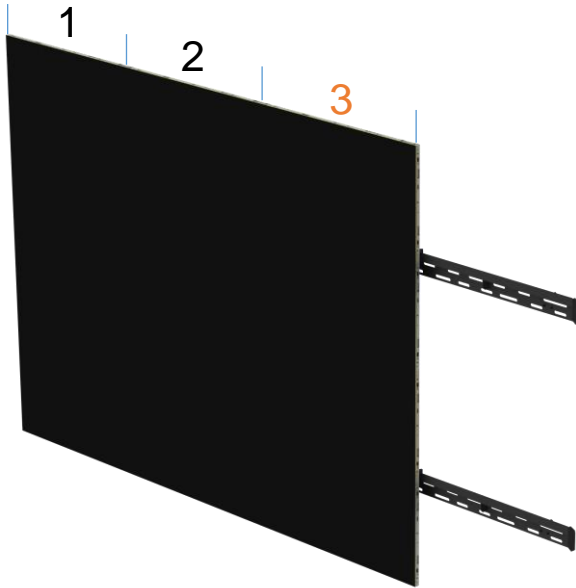

11. If installing into an inset, see “Last Column Installation in Recess” on page 64 before continuing. Column 4 requires all edge guards be removed before hanging on the mount bars. Make sure that both top and bottom far right hanger brackets are hooked on the mount bars, and slide column 4 in contact with column 3.

Caution: Do not slide the column to the right or the column may fall off the mount bars, causing injury and/or product damage.

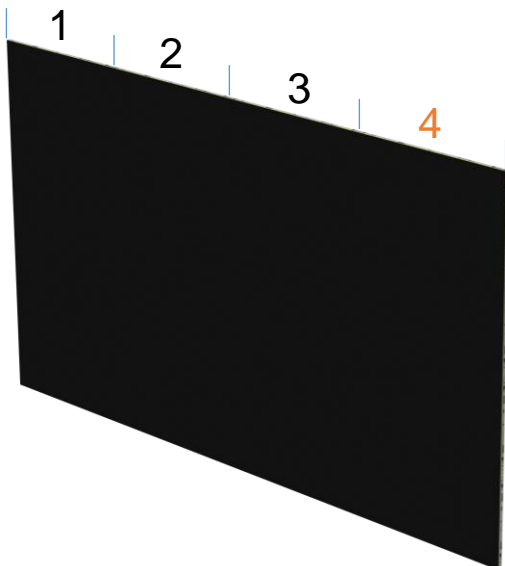

12. Remove the bottom row of LED modules and column 4's left second from top and left fourth from the top LED modules as shown. Reference the vacuum tool procedures at the end of this guide for LED module removal. See “LED Module Removal” on page 63.

Note: The modules have been optimized for the positions they are originally installed. When removing, it is highly recommended the modules be tracked and placed back in the same positions.

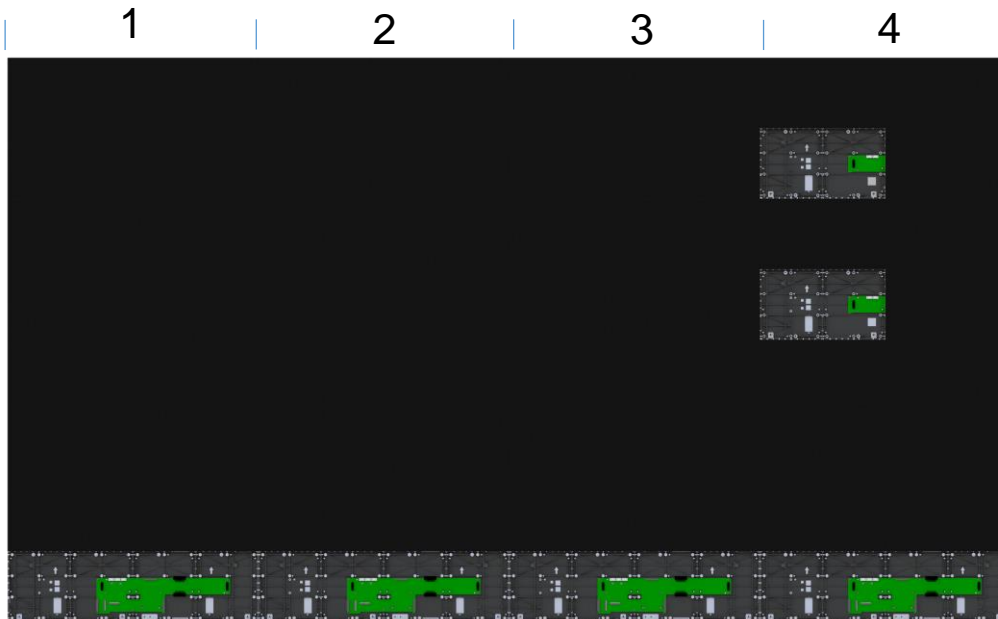

13. In the removed module areas in column 4, finger tighten (3X) M5 X 10 PHMS w/ lock and flat washer at the seam between columns 3 and 4 as shown.

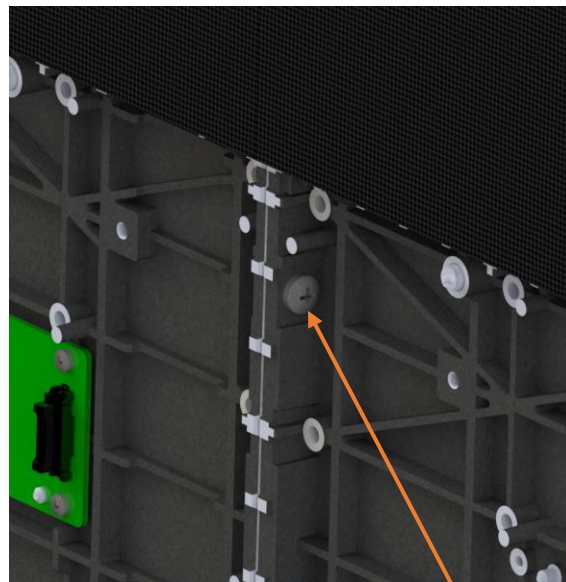
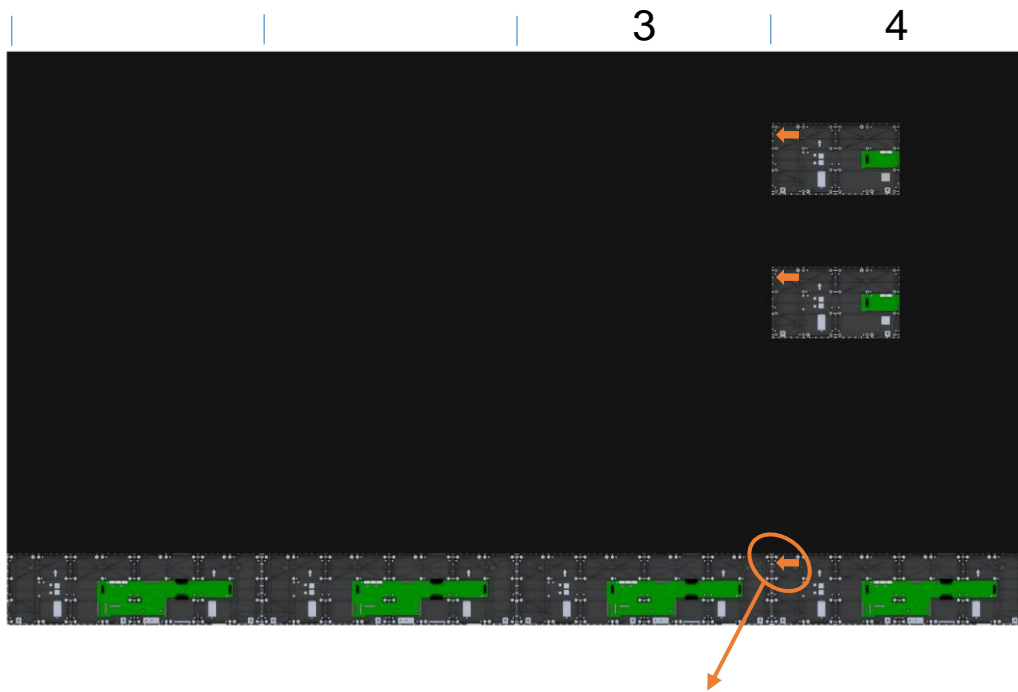

M5 X 10 PHMS

14. Use the vertical column alignment procedure from step 8 for the alignment between columns 3 and 4.
15. Tighten the screws from step 12 to the point where the column pixel gap is like a gap between pixels in the LED module.

10.7 Assembling and Installing Electronic Box

1. Unscrew the front covers from the electronics assemblies and remove. The covers are held in place by magnets as well so extra force may need to be used to remove.
2. Align the Left Electronics and Right Electronics assemblies as shown and push the pieces together over the bracket on a flat surface.

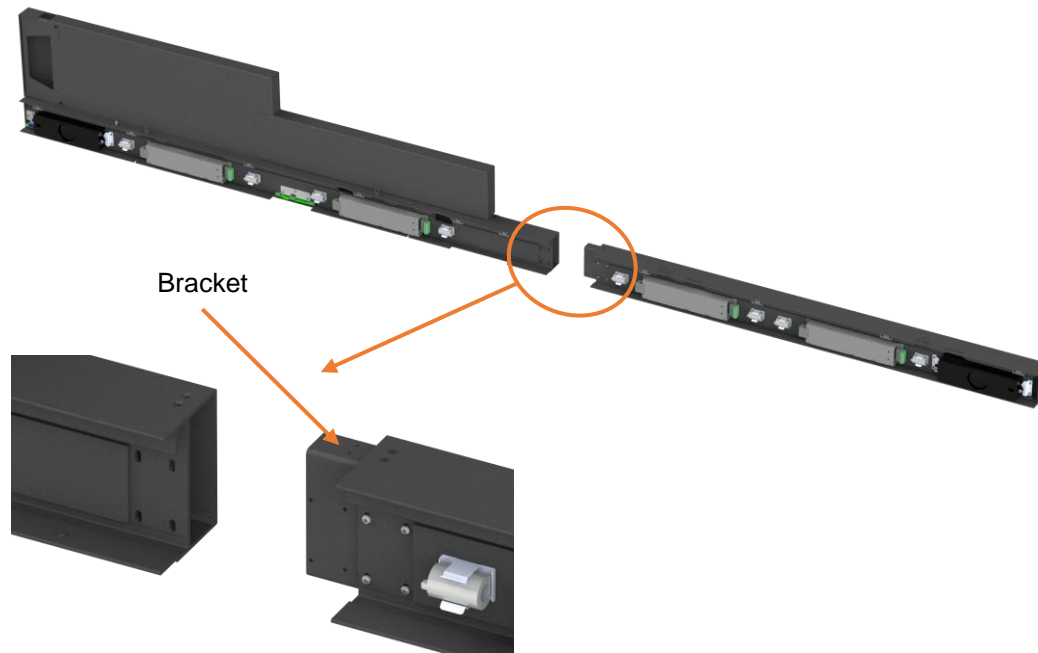

3. Install (4X) M3 X 6 PHMS screws and (2X) M3 X 6 FHMS BLK to secure the Left Electronics and Right Electronics assemblies.

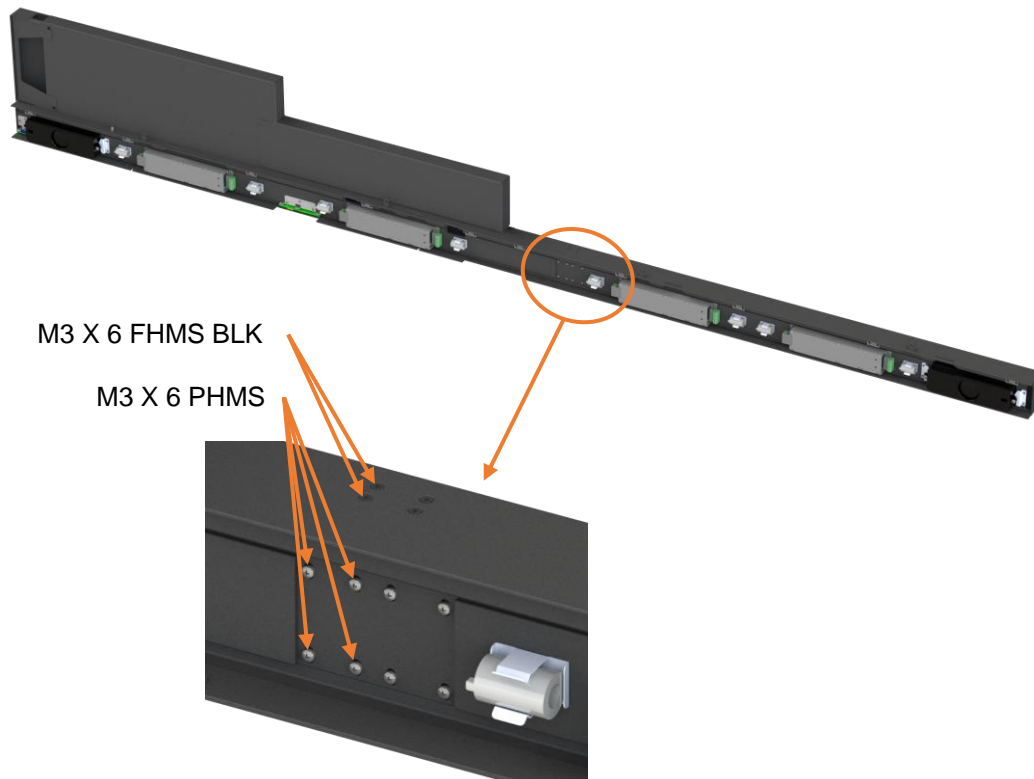

4. Connect audio and power cables between left and right electronics assemblies as shown.

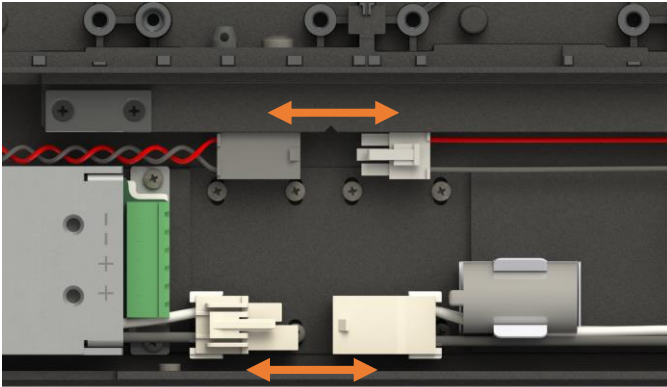

5. With two people, position the full electronics box under the bottom edge and slightly behind the columns as shown.



6. Raise the electronics box up, aligning the tabs and alignment pin with the cutouts and hole in the bottom edges of the columns.

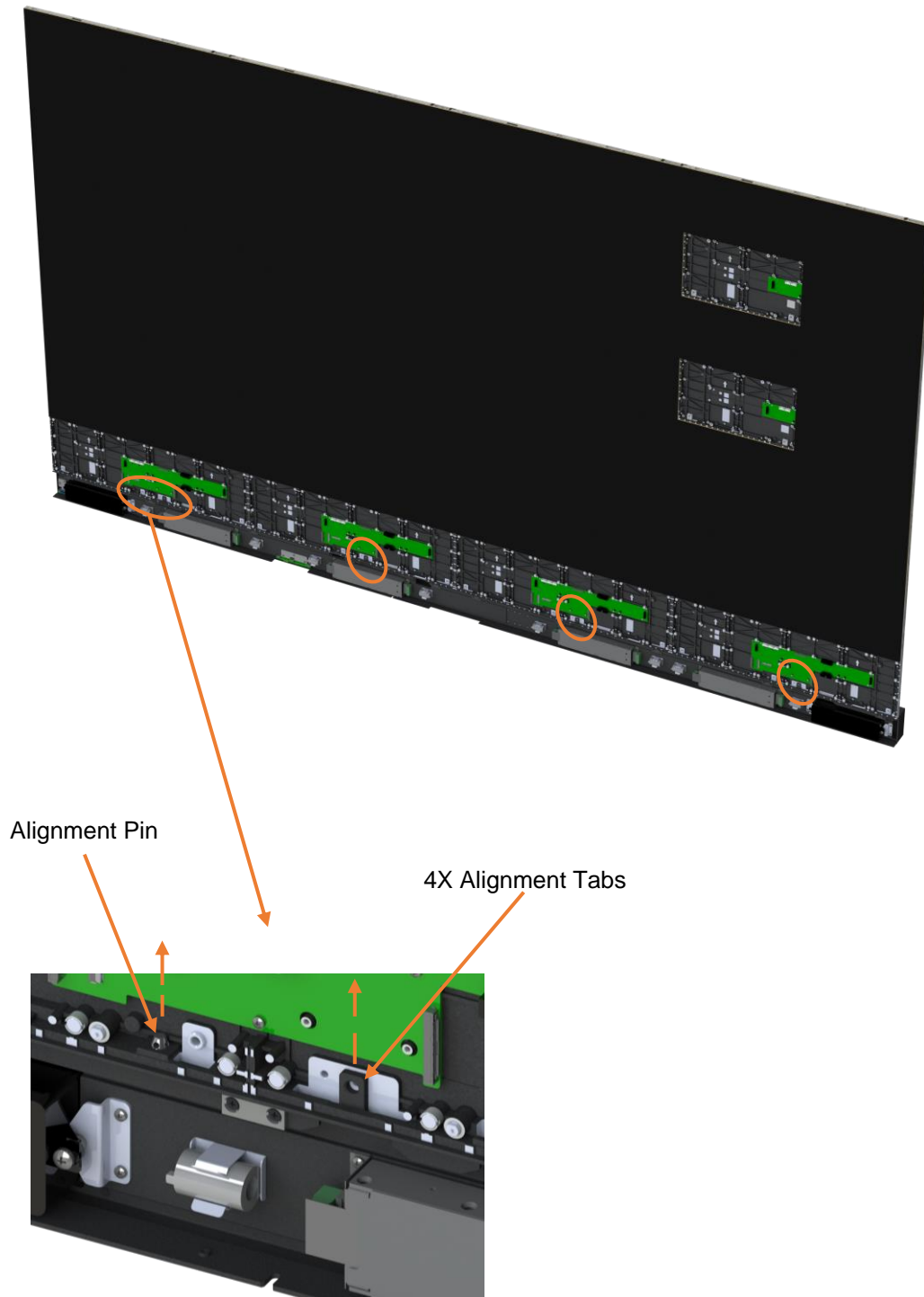

7. Install (4X) Tab Screws tightly as shown.

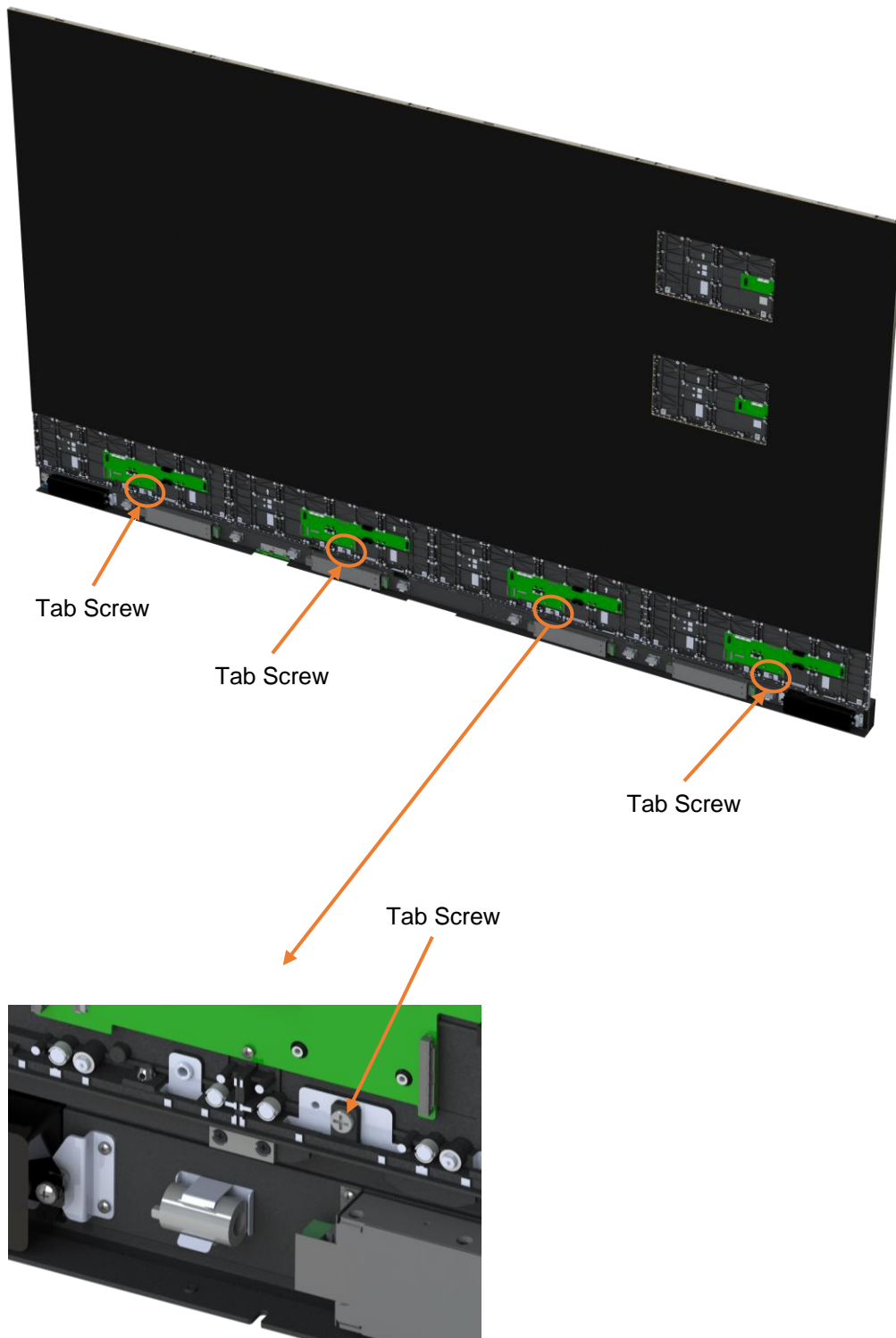

8. Connected to each power brick in the electronics box, route (4X) column power cables up through the cutouts in the electronics box and bottom of columns as shown. Connect each power cable to electronic boards where shown.

Caution: Be sure cables do not cross over magnets, chassis pads or alignment pins; this will cause LED modules to not be flat when installed.



4X Column Power Cables

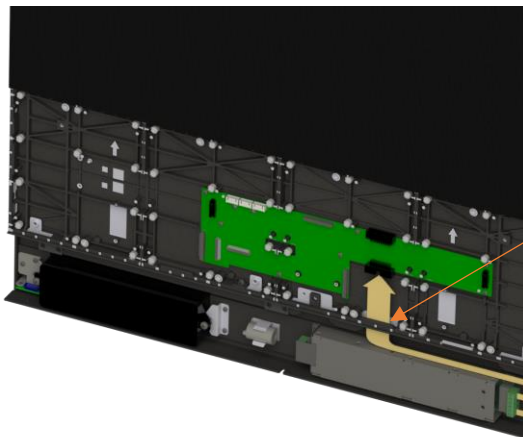

Cable Cutouts

9. Carefully remove the (2X) flat flex cables taped to the power bricks and connect to column 2 and column 3 electronic boards as shown.



2X Flat Flex Cables

10. To install the cable into the mating connector:
 - a. Flip up the black lever on the electronics board.

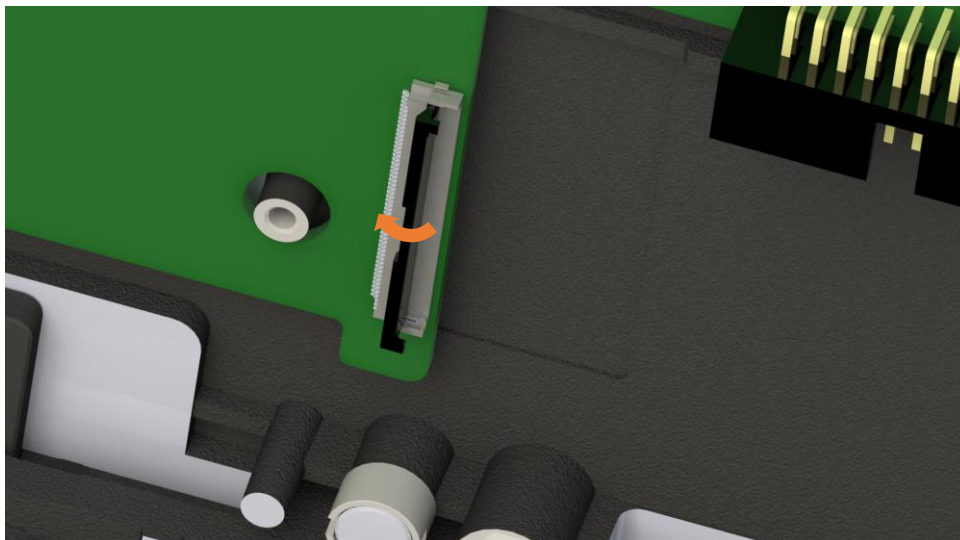

- b. Slide the latch at a slight up angle into the connector until the notch in the cable aligns with the catch in the connector. Tilting the cable up at an angle will help get the end started in the connector.

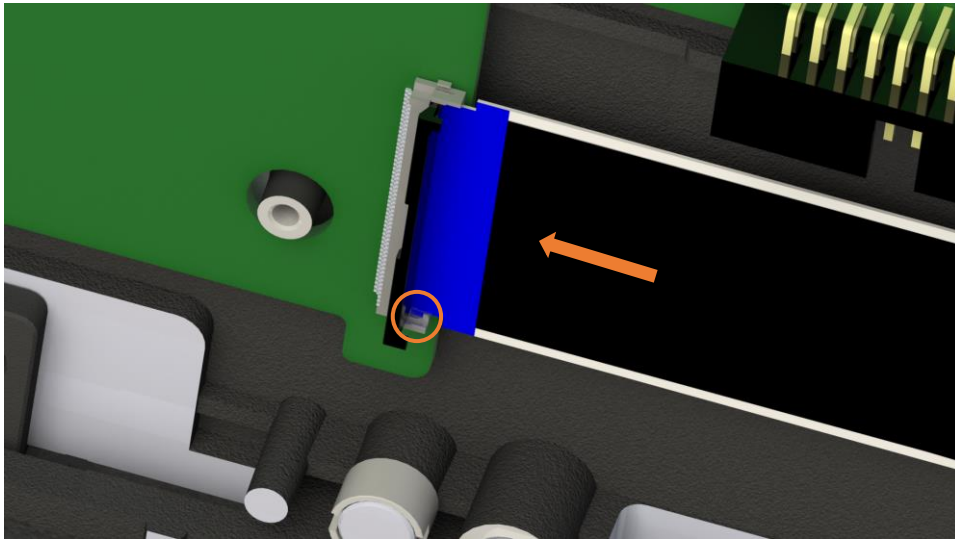

- c. Rotate the black lever down onto the cable until it snaps into place.

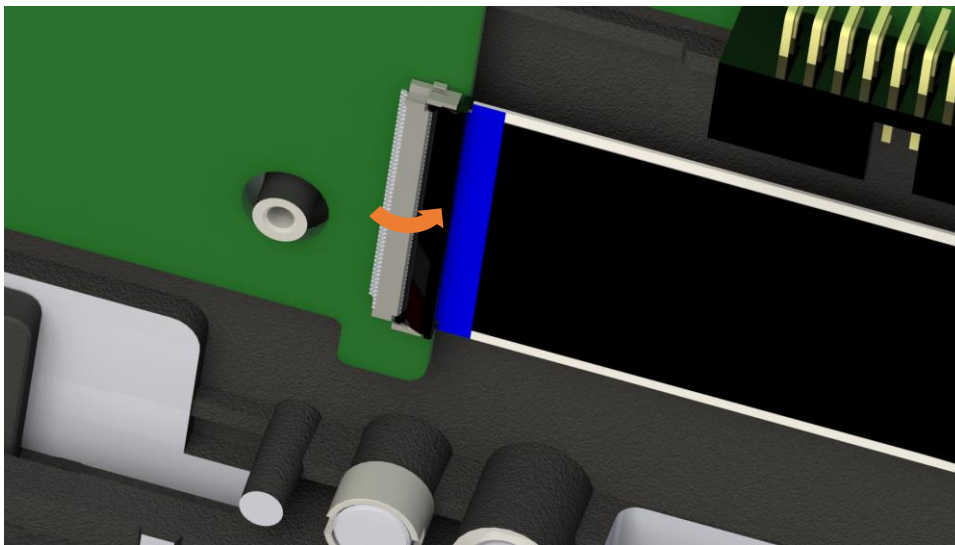

11. Connect (2X) flex signal cables between columns 1 and 2 and 3 and 4 electronic boards. Use the same procedure for cable connection as noted in step 11.



2X Column to Column Flat Flex Cables

10.8 Powering up and Test Display

1. Connect main power cord to the left electronics box AC inlet.
2. Connect a video source to an HDMI input.
3. Connect main power cord to 110V wall outlet and turn on main power switch next to the AC inlet.

Caution: Exposed power supplies in the electronics box has hazardous voltage. Be careful not to touch any parts in the exposed electronics area.

4. Verify that the splash screen appears in middle of display. Use the remote to browse to the Test Pattern menu and select white to verify the image is shown on all LED modules installed in the display.
5. If all modules displayed successfully, turn off the power switch and proceed with the next assembly procedure. If all the modules did not display correctly, see the “Troubleshooting” section on page 149.

10.9 Assembling and Installing Front Cover

The front cover contains the IR touch sensor.

Caution: Great care must be taken when handling these components, to ensure that the ribbon cables and pins that connect each portion of the sensor are not damaged during the assembly and installation process.

1. Place the right front cover and left front cover on a soft, flat surface as shown.

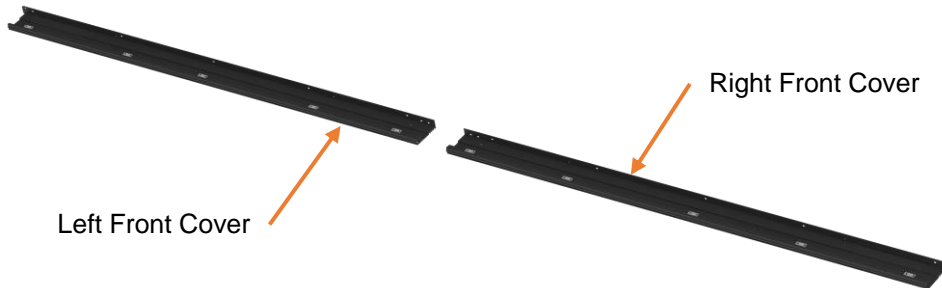

2. Carefully slide the right touch electronics to the left connecting the 16-pin plug into the 16-pin receptacle of the left touch electronics as shown.

Caution: Pins are easily damaged if not properly aligned.

Slowly slide the extrusion pieces together using the alignment pin for positioning.

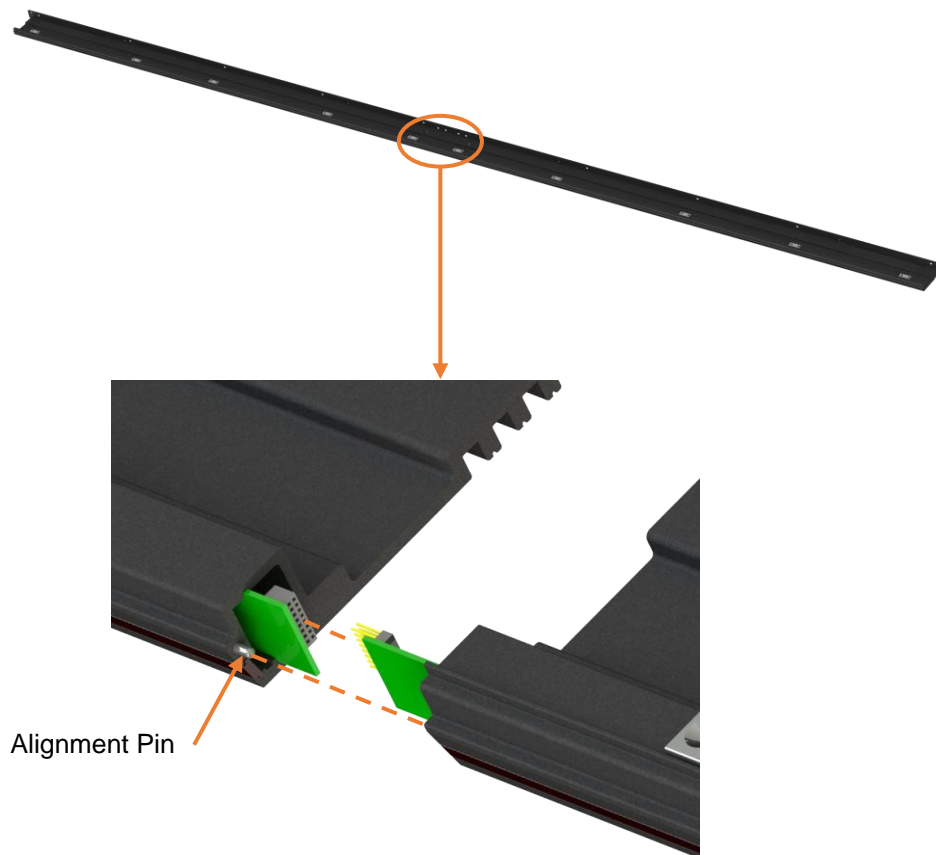

3. Once the left and right front covers are assembled, place the front cover bracket over the seam and secure with (8X) M3 x 6 FHMS BLK screws as shown.

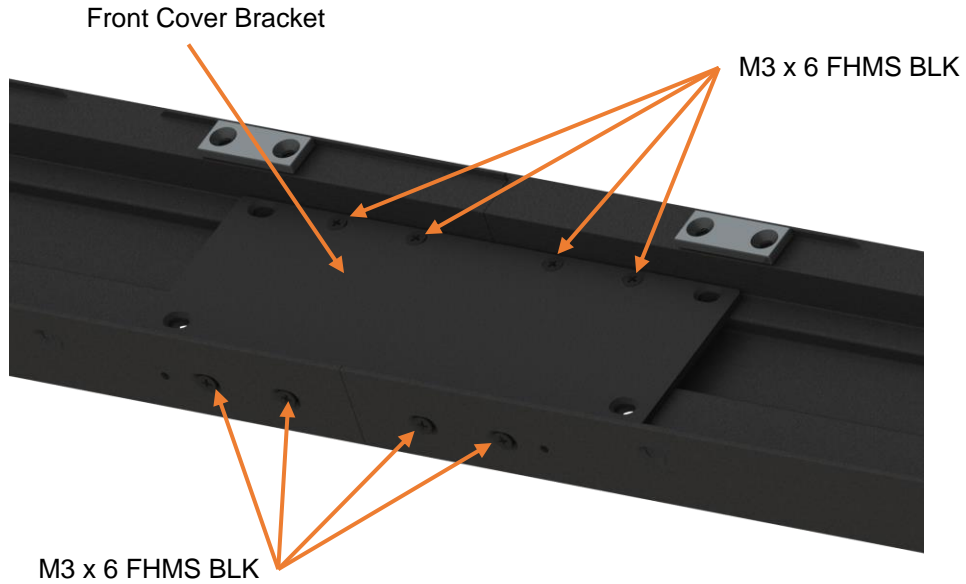

4. Rotate the front cover assembly so the front face is up and place the front cover over the seam with the (4X) threaded standoffs passing into the front extrusion counterbore holes as shown.

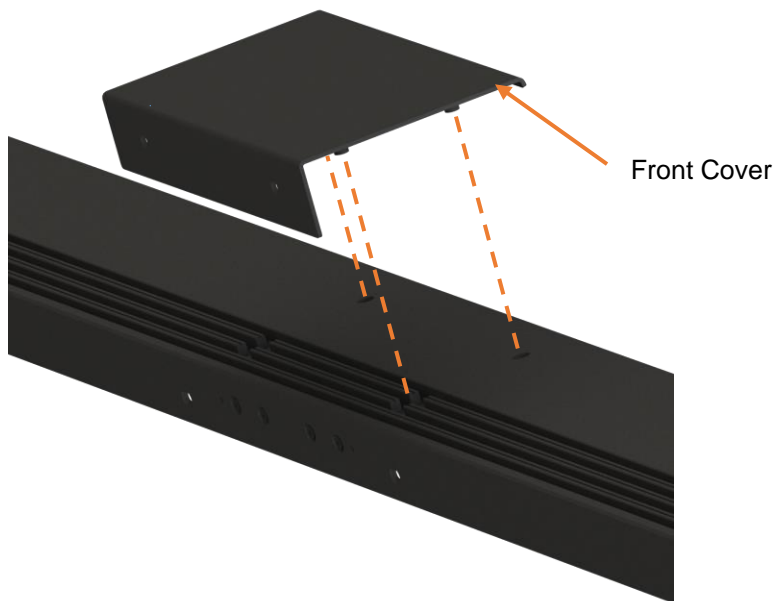

5. Rotate the front assembly back to the first position while holding the front cover in place. Install (4X) M3 x 6 FHMS BLK screws through the front cover bracket and threaded into the front cover standoffs. Next install (2X) M3 x 6 FHMS BLK screws into both the front extrusion flanges as shown.

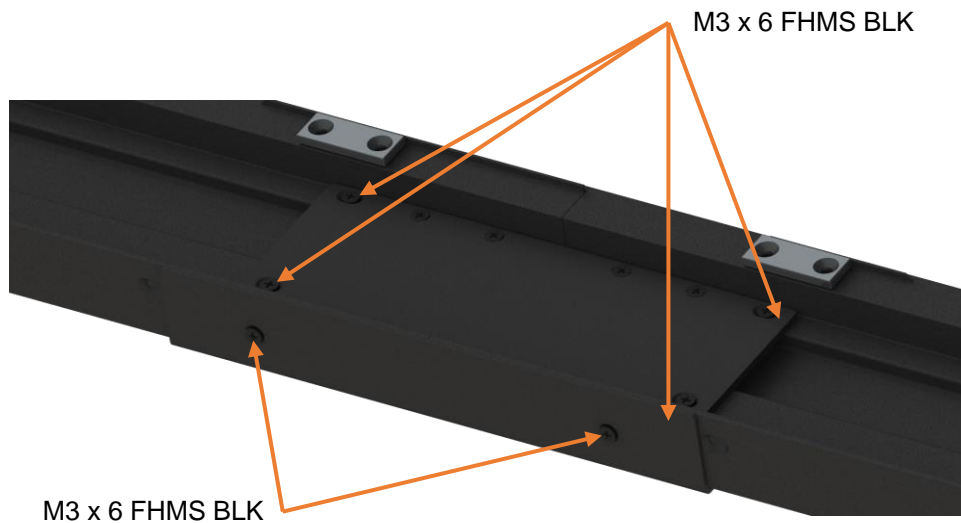

6. The front cover assembly is now complete.



7. Installation of the front cover assembly requires a close fit to the speakers, power supplies, and keeping cables clear of small spaces. The two main flat flex cables must be in the correct recessed locations. The power supply cables, which were connected in a previous assembly step, need to be positioned behind the flange. And the two cable connections required at the split need to be positioned flat against the electronics box surface. All other cabling and connectors must be routed along the internal components as the left and right electronics assemblies were shipped.

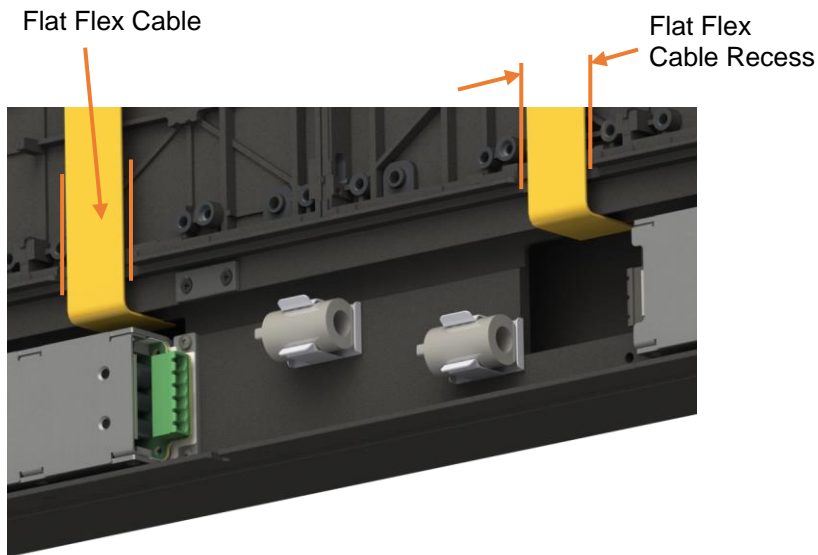
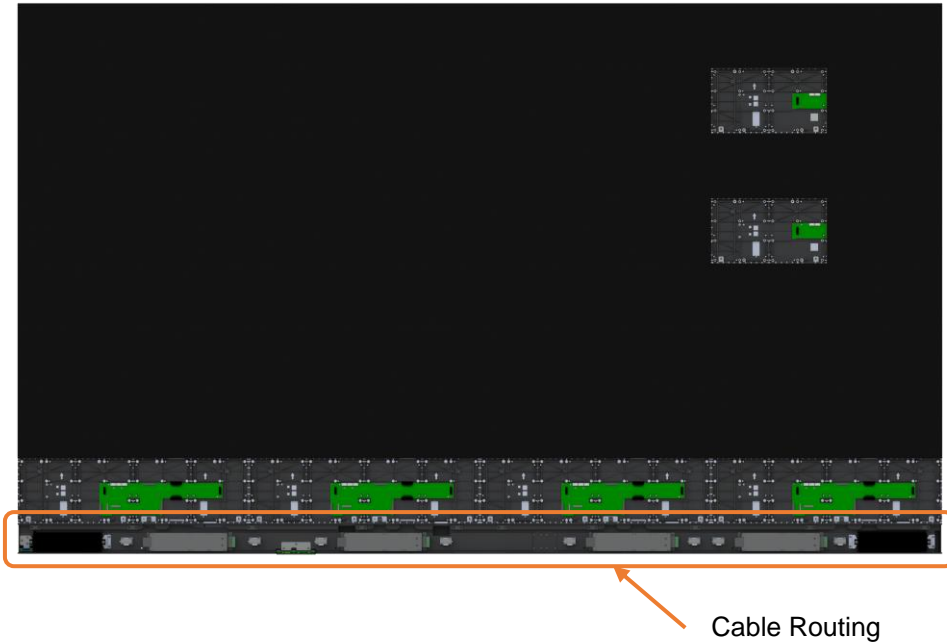

8. Position the front cover assembly in front of the display as shown.

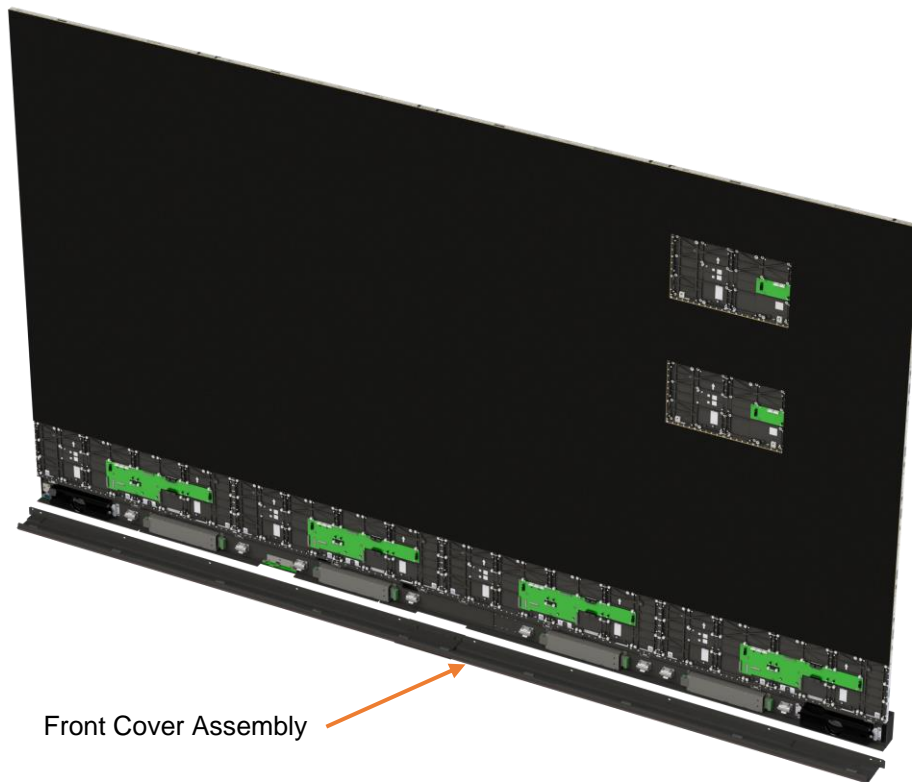

9. Connect the front cover USB cable to the USB cable from the electronics box assembly. Push any excess USB cable into the cavity on the electronics box.

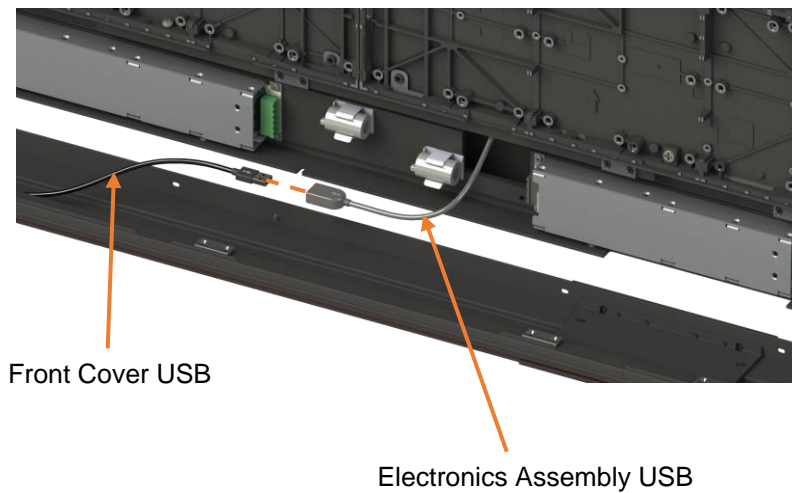

10. Position front cover assembly lining up alignment pins in lower flange to the slots in the electronics left assembly.

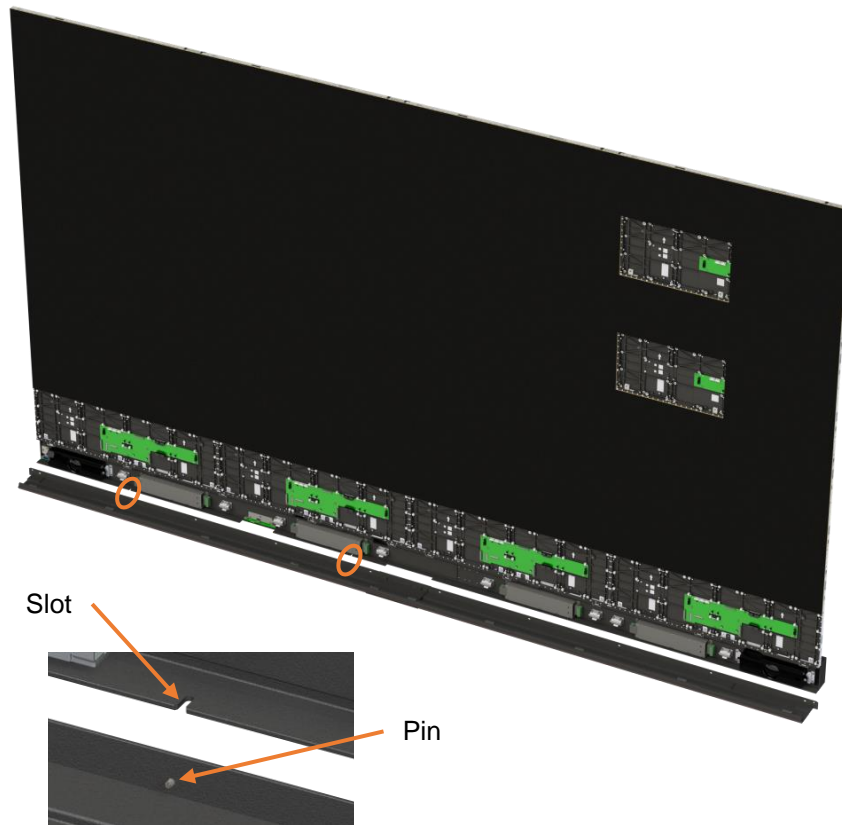

11. Rotate the front cover to vertical, being careful not to allow any cables to interfere between the electronics along the top edge of the front cover. The magnets should engage, holding the cover in place. The cover should look aligned and symmetric. If the cover is bulging or does not appear to be fitting properly, remove it and adjust the cables that may be causing the issue.

10.10 Installing Side and Top Trim Parts

The side and top trim parts contain the IR touch sensor.

Caution: Great care must be taken when handling these components, to ensure that the ribbon cables and pins that connect each portion of the sensor are not damaged during the assembly and installation process.

1. Place the top left trim on the top left side of the display and install 1X M3 x 6 FHMS BLK in the first mounting hole on the left end of the trim piece as shown.

Caution: There are magnets near the mounting holes that can attract a loose screw as it is installed.

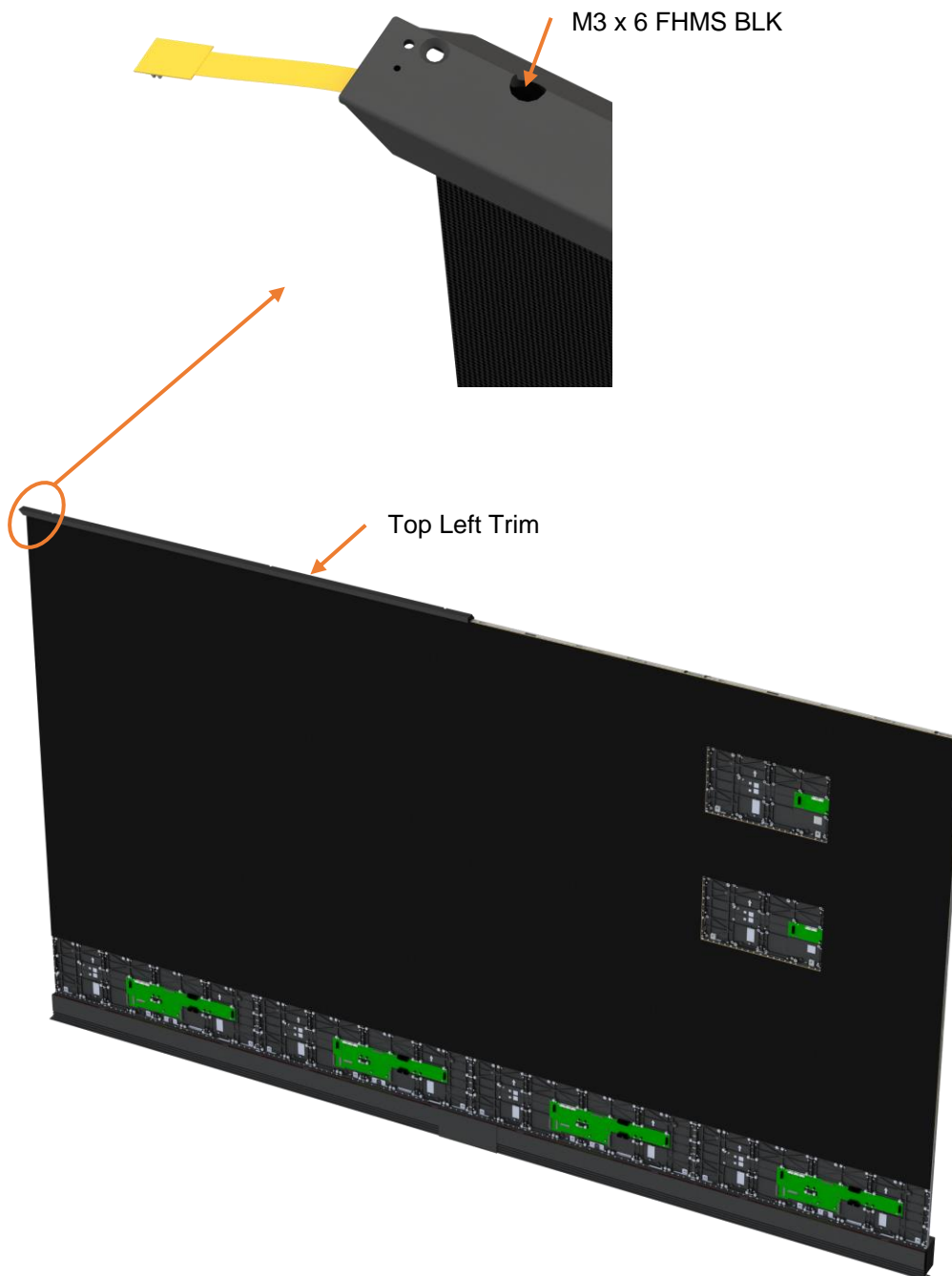

2. Place the top right trim on the top right side of the display shifted to the right approximately 50 mm to prevent damaging the connector pins exposed from the top left trim as shown.

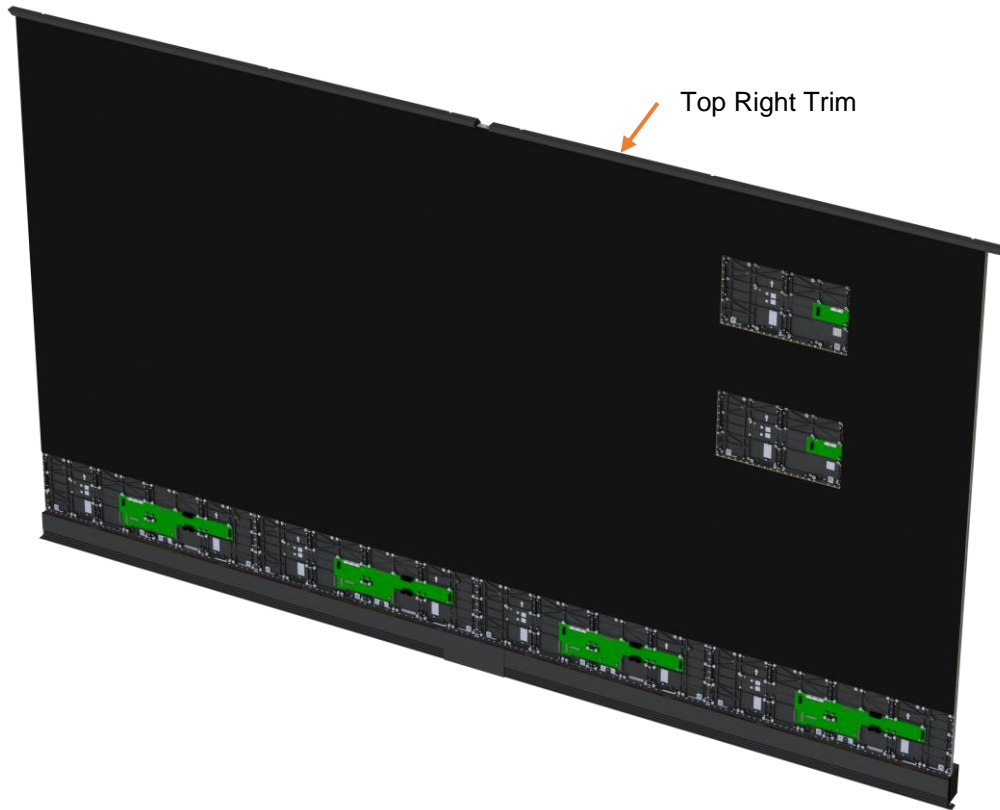

3. Carefully slide the right touch electronics out of the left trim to connect the 16-pin plug into the 16-pin receptacle of the right touch electronics as shown.

Caution: Pins are easily damaged if they are not properly aligned.

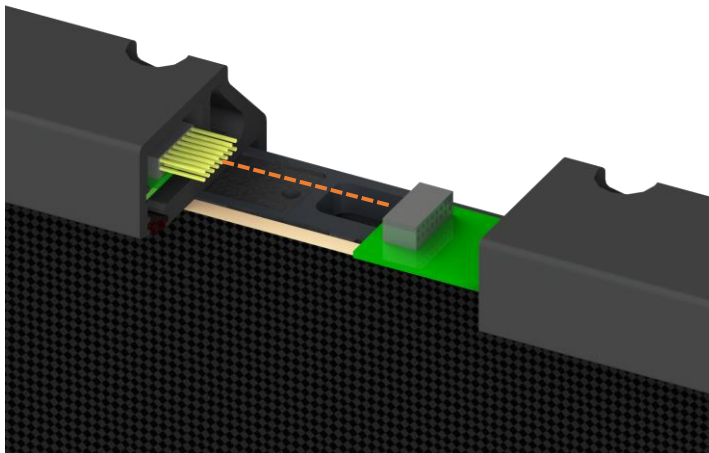

4. With the electronics connected, slide the top right trim to the left against the top left trim as shown. Secure the top trim pieces with 5X M3 x 6 FHMS BLK as shown.

Caution: There are magnets near the mounting holes that can attract a loose screw as it is installed.

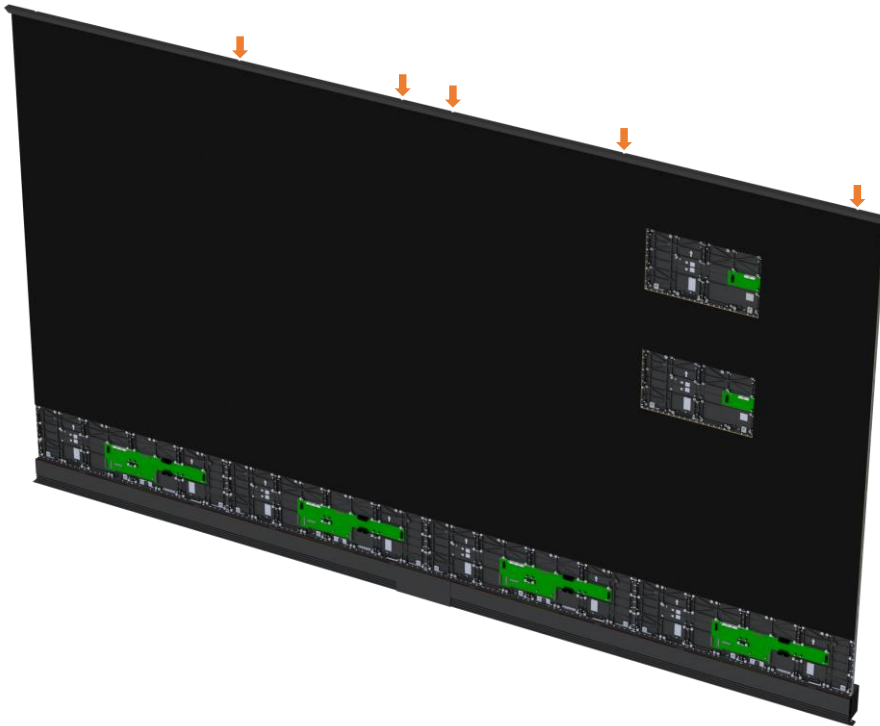

5. Place the right side trim along the right side of the display as shown. The magnets on the side of the display column will hold the side trim in place. Use a M3 x 20 FHMS BLK to secure the upper right corner as shown.

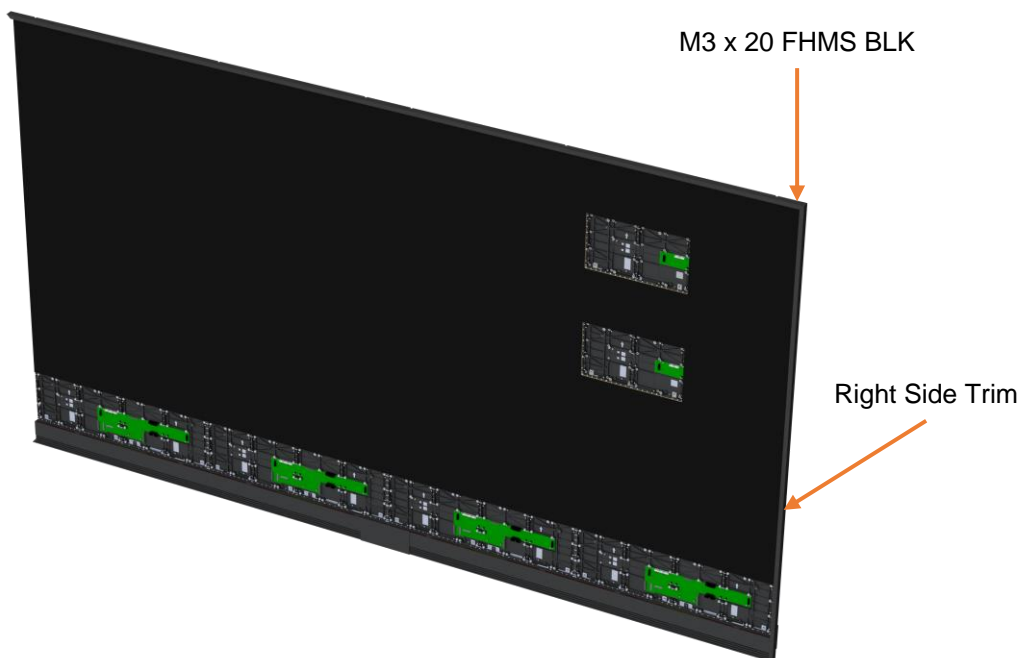

6. Position the left side trim near the left side of the display and align the ends of the touch flex cables together as shown and press the connectors together. Gently fold the cable assembly over and slide the end of the connection along the inside surface of the left side trim.

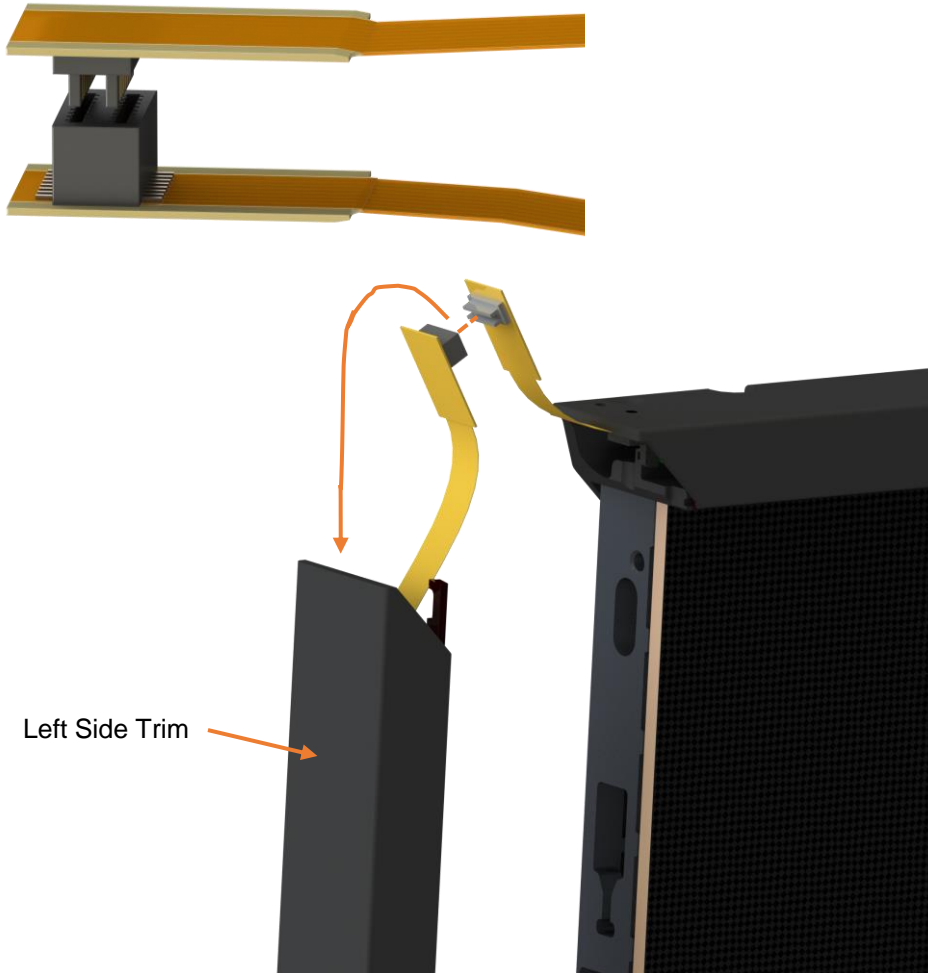

7. While moving the left side trim corner up to meet the top left trim corner, carefully coil the remaining flex cable so that it fits in the corner of the top and side trim. The magnets on the side of the display column will hold the side trim in place. Install a M3 x 20 FHMS BLK to secure the upper left corner as shown.

M3 x 20 FHMS BLK

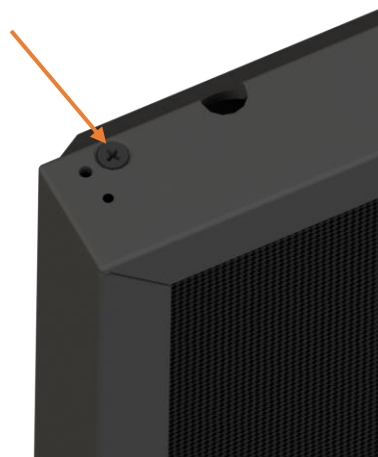

8. Slightly pull the bottom of the left side trim away from the side of the display to gain access to the touch flex cables. Connect the left side touch flex cable to the mating connector, aligning the ends of the flex cables as shown in step 6. Carefully store the excess cable into the open area of the trim and front cover. Next move the left side trim back to its original position against the magnets on the side of the display, being careful not to pinch the cable. Repeat the touch cable connection at the bottom of the right side trim using the same procedure.

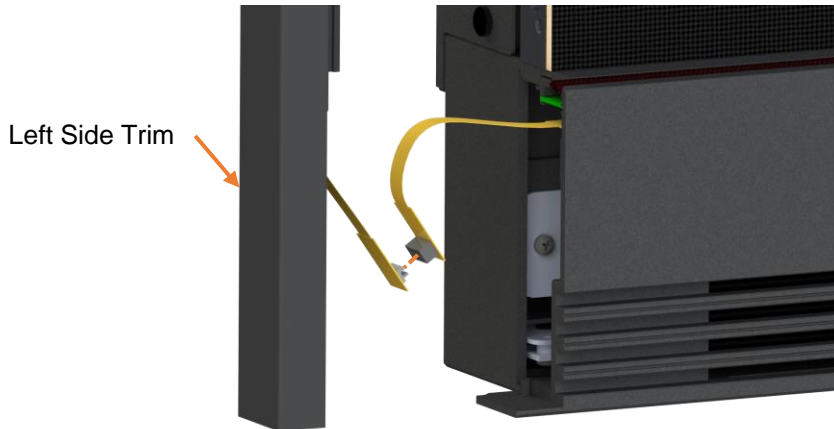

9. Install (2X) M3 x 6 FHMS BLK through the bottom flange of the electronics assembly to secure the bottom of the side trim pieces as shown.



10. Install the modules that have been removed from the display. See step 3 on page 63.

11. Install (10X) M3 x 6 FHMS BLK up through the bottom flange of the front extrusion assembly as shown.

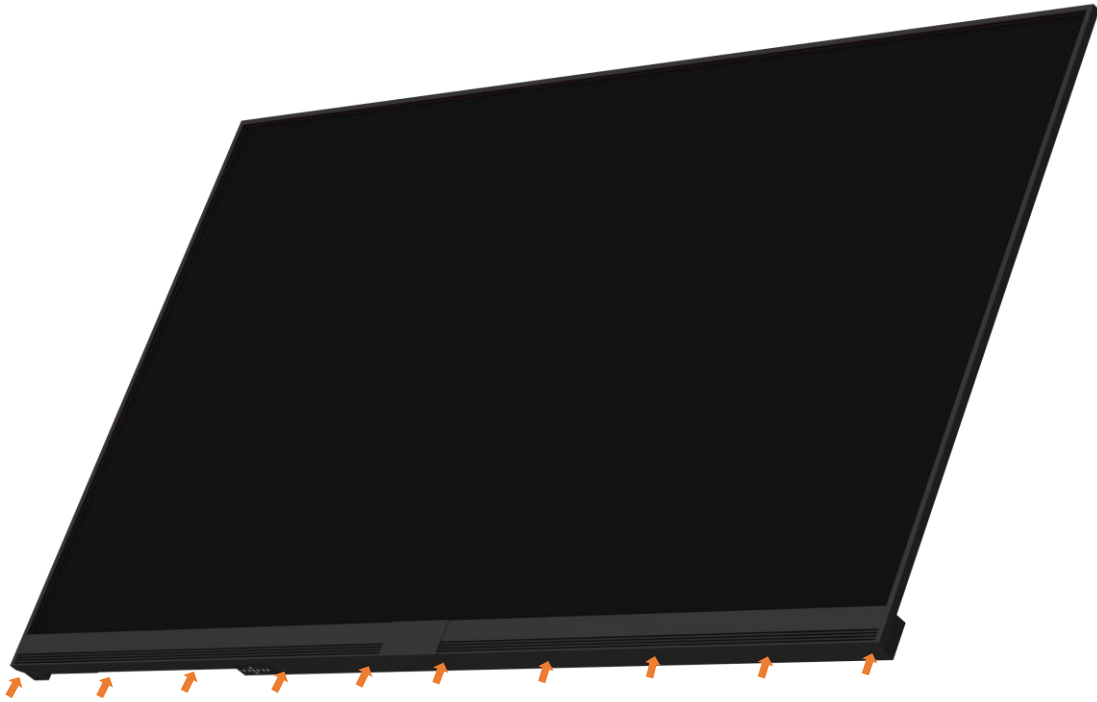

12. Connect the sources and other cables as needed and turn on power to the display. The display comes with a cable cover for the side cable connections, which may be removed by unscrewing the two screws shown below. The area under the cable cover also has a pass-through to route cables from top to bottom of the display.

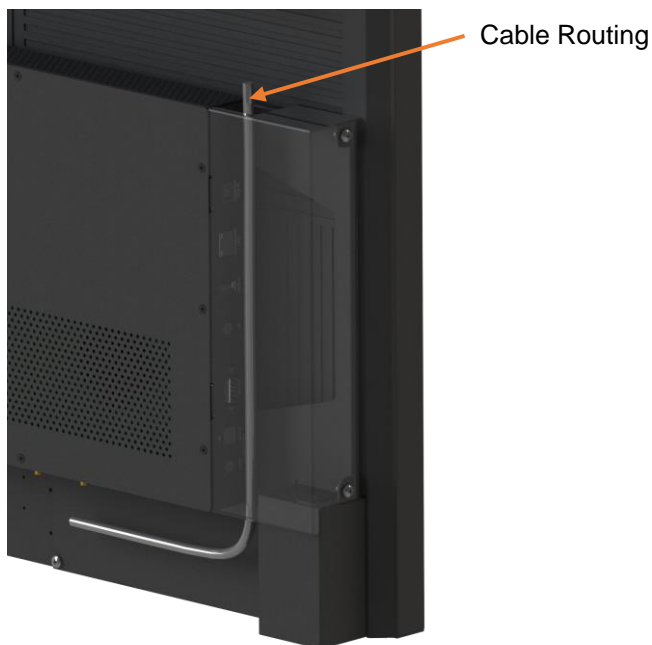

11. LED Module Removal

1. For removal of LED modules, a suction tool is provided in the accessory kit. Be sure the rocker switch is on and that the battery has been charged. To remove a module, follow the steps below:
 - a. Place the tool in the orientation shown in the center of a module to be removed and gently apply pressure
 - b. Press the button at the top of the handle. The button may be released and the suction will continue.
 - c. Pull the module straight out perpendicular to the display.
2. To remove a module from the tool, support the back of the module with one hand while pressing the button again. The suction will turn off and the module will be free to place in a protected place while working on the display.
3. To replace a LED module, the tool is not required. Using both hands, line up the LED module with the open area of the display and carefully bring closer to the display. The magnetic force from the display will pull the module into place. If an edge does not seat properly, then the module may need to be removed and re-positioned again. Never force a LED module into place; this can cause damage to an adjacent or the LED module being installed.

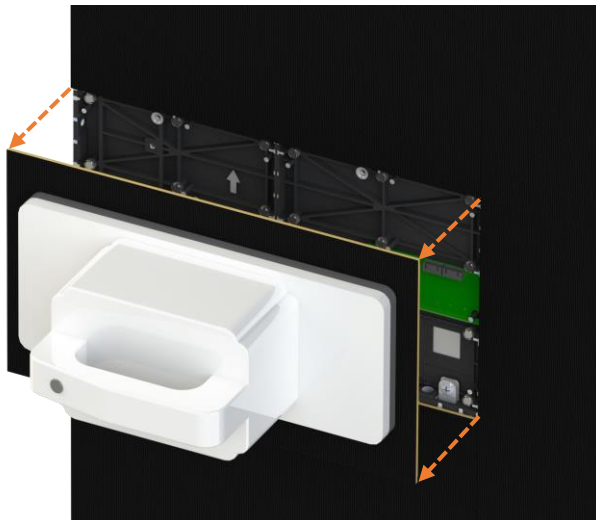
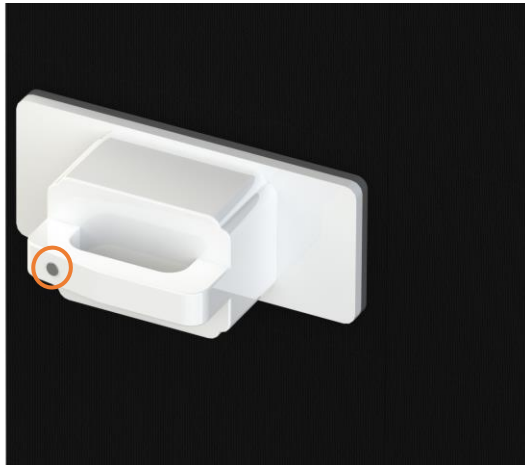

12. Last Column Installation in Recess

1. To temporarily assist with column installation in a small recess, handles are provided in the accessory kit. Before installing column 4, remove the side column edge guards. Next, remove the LED modules (see “LED Module Removal” on page 63) as shown below and attach the handles as shown using M4x8 screws as shown. Remove the handles once column is in place.

Note: Handles do not eliminate the need for space at the top or the bottom of the display, only the sides.

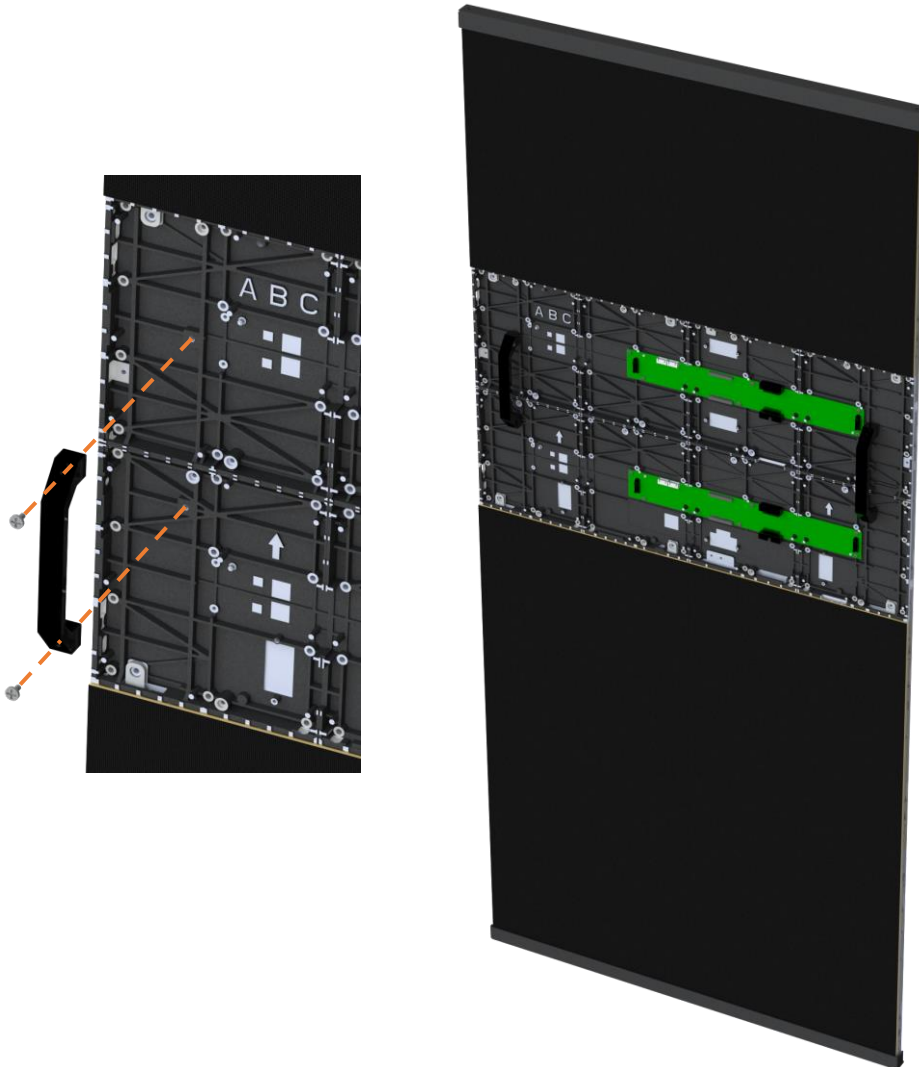

13. Adjusting Module Flatness

The Planar UltraRes L Series display will come pre-adjusted as necessary out of the box. However, there may be a need to fine tune the flatness due to a replacement module or a module placed in a different location than where it was when it came out of the box. Follow the procedure below to adjust modules as needed.

1. Determine which module is out of flat. Typically this will be the one that is not aligned with all the surrounding modules. This can be seen visually as dark lines in a bright image and/or felt with a finger as it is dragged over the surface of the display.



2. Remove the module and use the magnet adjust tool to tighten or loosen the magnet in the area where the module is out of flat. Tightening will lower the module and loosening will raise the module. Typically the amount of adjustment will be small.

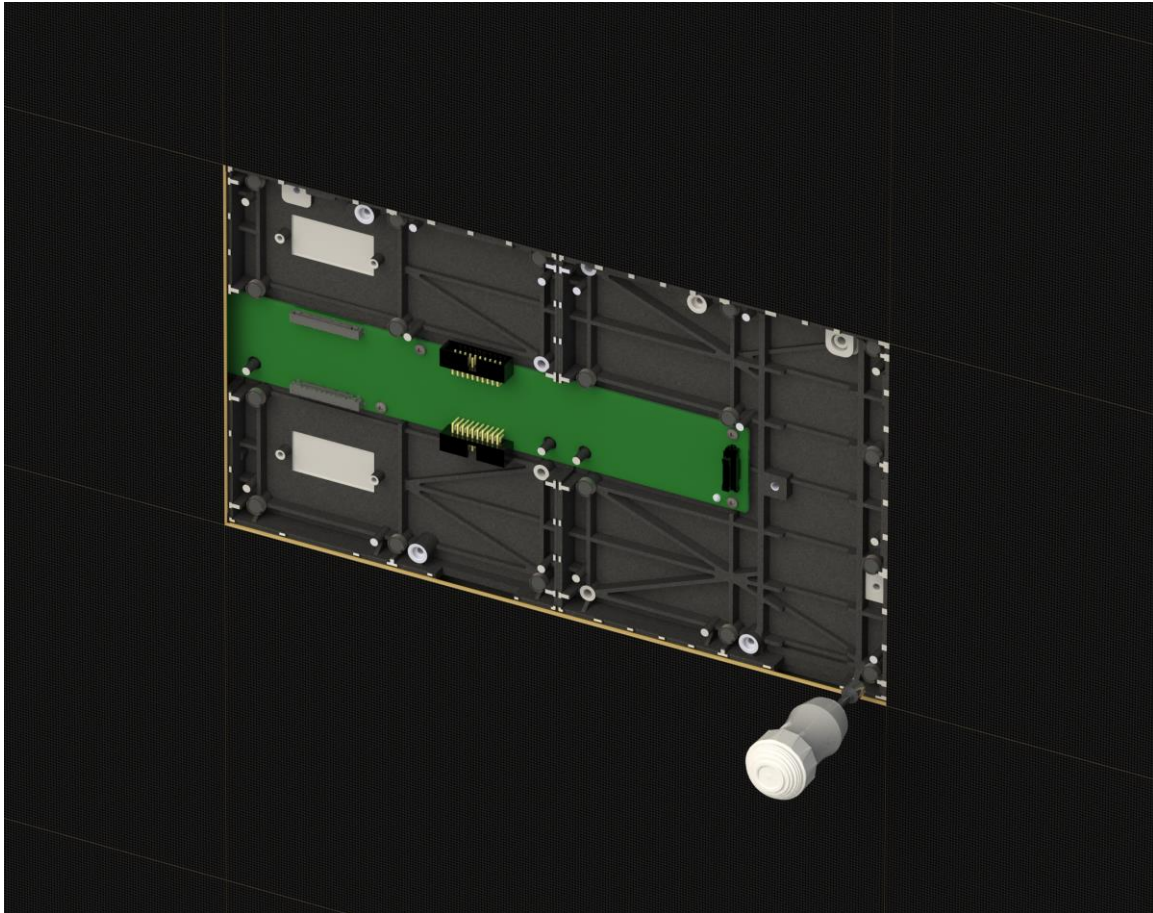

3. Re-install the module to the location and verify it is aligned with adjacent modules. If it is not, repeat the process until results are satisfactory



14. Mounting a Peripheral Device

A 75mm x 75mm VESA mounting interface is located on the rear of the display to accommodate a third-party media player or computer. Note that this is only accessible when installed on an optional rolling floor stand.

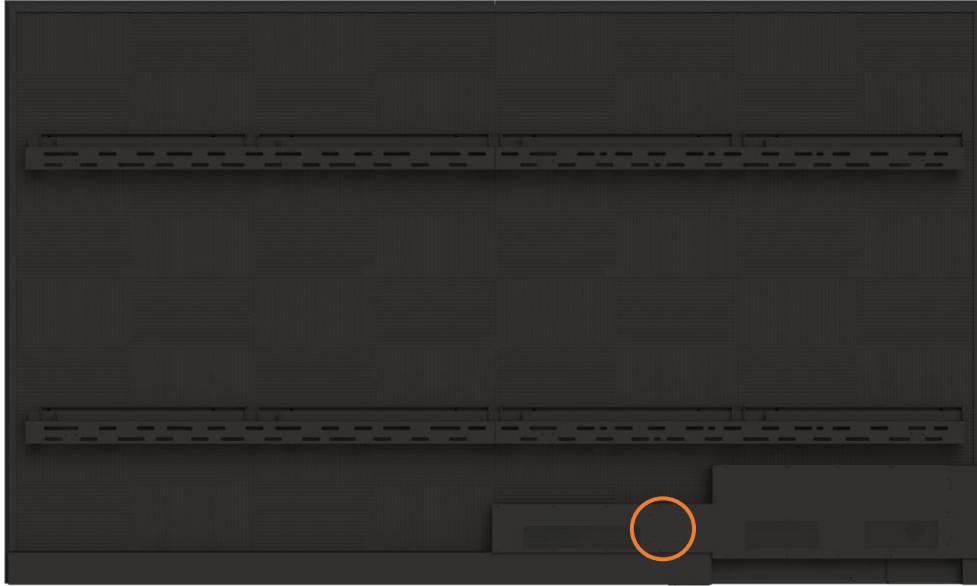

Operating the Display

15. OSD Keypad

The OSD keypad is located on the rear of the display.

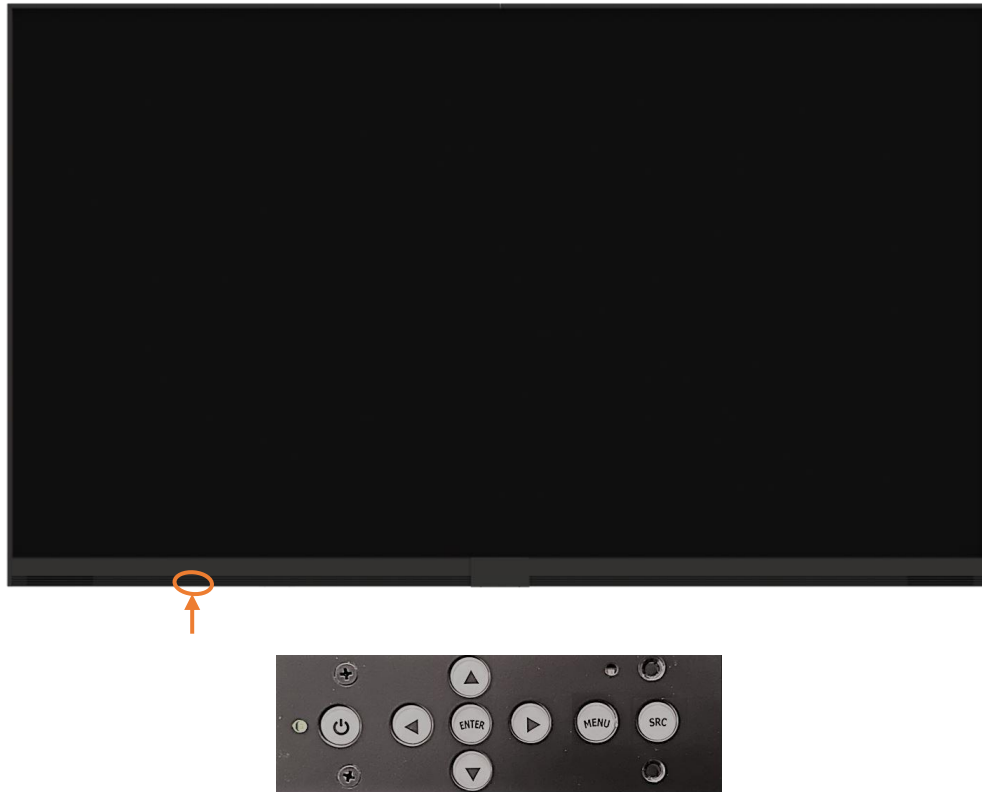

OSD Keypad Buttons

Key	Descriptions
Power	Power on/Power off
◀	Menu Left/Decrease value
▶	Menu Right/Increase value
▲	Menu Up/Increase volume
▼	Menu Down/Decrease volume
Menu/Exit	Menu/Exit
Source	Source selection (toggle)

16. Remote Control Receiver

The location of the IR remote control receiver is highlighted in the images below. An IR extender cable is included in the accessories package for additional flexibility.



17. LED Indicators

The LED indicator light is located on the rear of the display near the keypad. The following tables explain what the different colors and blink patterns mean.

LED On

Power Status	Condition
Green	Standby mode
Amber	Full power mode
Green Flashing (1 Hz)	AC power on
Green Flashing (0.5 Hz)	Powering on from standby
Green Flashing (5 Hz)	Firmware updating
Amber Flashing (5 Hz)	Power supply failure
Green and Amber	Firmware update failure

18. Using the Remote Control

Below is a picture of the remote. See next section for Hex codes.



18.1 Changing Batteries

1. Remove the battery cover.

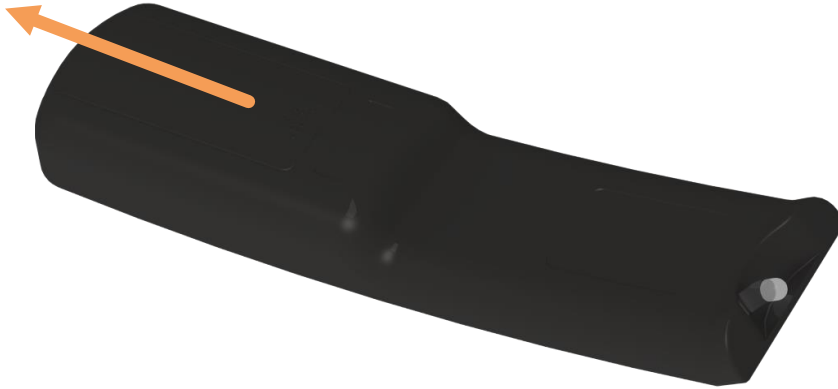

2. Remove the batteries.

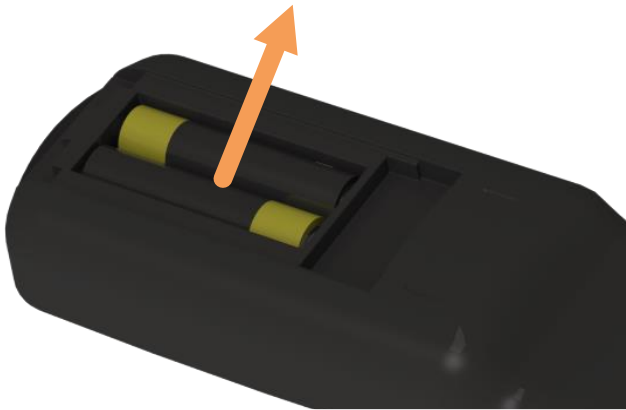

3. Verify the orientation of the replacement battery for each compartment.



4. Install the batteries.

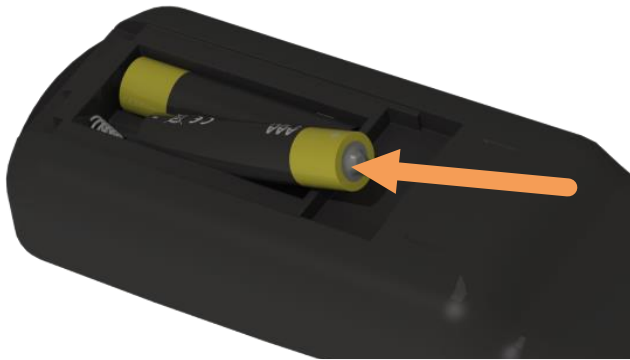

5. Replace the battery cover.



19. IR Command Protocol

The Planar UltraRes L Series displays accept commands in the form of IR signals that conform to the NEC protocol. Each Planar UltraRes L Series remote control has an NEC control code associated with it. These codes may be used to program a third-party “universal” remote control to work with the Planar UltraRes L Series displays. These third-party products usually come with a computer software application for this purpose. For more information, consult the documentation provided with the remote control.

The IR control codes have the following characteristics:

- Each code consists of the following:
 - A leader pulse (a modulated pulse of 9 ms followed by a non-modulated pulse of 4.5 ms)
 - 16 address bits. The default address is 1785 (0x06F9, binary 00000110 11111001)
 - 16 data bits: eight (8) bits for the command followed by the logical inverse of the command
 - An end pulse (a modulated pulse of 0.56 ms, similar to the modulated pulse in the ‘0’ and ‘1’ bits). The end of the modulated pulse constitutes the end of the data transmission.
 - The carrier frequency is 38 kHz, with the modulated pulses having a 33% duty cycle.
 - Commands are sent at a maximum rate of 9 Hz.

For example, below is the NEC control code for the ON button of the Planar UltraRes L Series remote control (assuming the default address is used).

Hex	06	F9	01	FE
Binary	00000110	11111001	00000001	11111110
Function	Address Byte 1	Address Byte 2	Command	Command (Logical Inverse)
	1	2		

The following example shows the pulse train for this command.



19.1 Hex Codes

Remote Control Button Name	Address	Data	NEC Data From Remote (Hex Code)	Description
ON	1785	1	0x06F901FE	Power on
OFF	1785	9	0x06F909F6	Power off
◀	1785	2	0x06F902FD	Not used
▶	1785	3	0x06F903FC	Not used
**	1785	6	0x06F906F9	Not used
PRESETS	1785	4	0x06F904FB	Opens the Presets menu
PRESET 1	1785	5	0x06F905FA	Applies Preset 1
PRESET 2	1785	7	0x06F907F8	Applies Preset 2
PRESET 3	1785	8	0x06F908F7	Applies Preset 3
PRESET 4	1785	10	0x06F90AF5	Applies Preset 4
1	1785	12	0x06F90CF3	Number button 1
2	1785	13	0x06F90DF2	Number button 2
3	1785	14	0x06F90EF1	Number button 3
4	1785	15	0x06F90FF0	Number button 4
5	1785	16	0x06F910EF	Number button 5
6	1785	17	0x06F911EE	Number button 6
7	1785	20	0x06F914EB	Number button 7
8	1785	25	0x06F919E6	Number button 8
9	1785	27	0x06F91BE4	Number button 9
0	1785	18	0x06F912ED	Number button 0
VOL +	1785	28	0x06F91CE3	Volume increase
VOL -	1785	33	0x06F921DE	Volume decrease
MUTE	1785	32	0x06F920DF	Audio mute
COLOR	1785	19	0x06F913EC	Not used

Remote Control Button Name	Address	Data	NEC Data From Remote (Hex Code)	Description
VIDEO WALL	1785	34	0x06F922DD	Opens the Tiling menu
MISC	1785	11	0x06F90BF4	Opens the Image Information menu
MENU	1785	21	0x06F915EA	Opens the menu
PREV	1785	22	0x06F916E9	Returns to the previous menu
ENTER	1785	23	0x06F917E8	Selects the current menu item
UP	1785	26	0x06F91AE5	Navigate up
LEFT	1785	29	0x06F91DE2	Navigate left
RIGHT	1785	31	0x06F91FE0	Navigate right
DOWN	1785	24	0x06F918E7	Navigate down
TOP	1785	30	0x06F91EE1	Selects the top line in the current menu
ZONE 1	1785	35	0x06F923DC	Selects the input for Zone 1
ZONE 2	1785	36	0x06F924DB	Selects the input for Zone 2
ZONE 3	1785	38	0x06F926D9	Selects the input for Zone 3
ZONE 4	1785	39	0x06F927D8	Selects the input for Zone 4
PIP MODE	1785	37	0x06F925DA	Selects the Multi-Source View setting
PIP SWAP	1785	40	0x06F928D7	Swaps the main and PIP windows
HDMI 1	1785	41	0x06F929D6	Selects HDMI 1 for the current zone
HDMI 2	1785	42	0x06F92AD5	Selects HDMI 2 for the current zone
HDMI 3	1785	43	0x06F92BD4	Selects HDMI 3 for the current zone
HDMI 4	1785	44	0x06F92CD3	Selects HDMI 4 for the current zone
DP	1785	45	0x06F92DD2	Selects DP for the current zone
DVI	1785	46	0x06F92ED1	Not used
VGA	1785	47	0x06F92FD0	Not used
OPS	1785	48	0x06F930CF	Not used

19.2 Locking the Keypad and IR Remote

The keypad and IR remote functionality can be locked on the display. To lock the keypad, go to Main Menu -> Advanced Settings -> System Settings and select Keypad Lock. To lock the IR remote, go to Main Menu -> Advanced Settings -> System Settings and select IR Remote Lock.

19.3 Unlocking the Keypad and IR Remote

To unlock the keypad, press the following keys on the keypad in the order listed: UP, UP, RIGHT, LEFT, DOWN. If the IR remote is unlocked, unlocking the keypad can be done by using the IR remote to go to Main Menu -> Advanced Settings -> System Settings and uncheck Keypad Lock.

To unlock the IR remote, press the following keys on the IR remote in the order listed: UP, UP, RIGHT, LEFT, DOWN. If the keypad is unlocked, unlocking the IR remote can be done by using the keypad to go to Main Menu -> Advanced Settings -> System Settings and uncheck IR Remote Lock.

19.4 Changing the IR Remote Code Set

The IR remote code set transmitted by the remote and accepted by the display can be configured. This is useful if there are multiple Planar displays in the installed area and each display needs to be operated independently. It can also be used if IR interference with another device, such as a DVD player, is occurring.

To change the IR code on the remote, use the following procedure:

1. Press and hold the CODE button on the remote control until the LED on the remote lights solid red (approximately five seconds).
2. Enter a new five-digit code between 00000 and 65535. Include leading zeros for codes with four or fewer digits; for example, enter 255 as 00255.
3. The LED turns off to confirm the code change. If an invalid code was entered, the LED flashes for three or four seconds. Try again, entering a valid code.

Note: The code must match the IR Remote ID Code setting. See page 109.

19.5 Turning the Display On

1. Insert the power cord into the display and into the power outlet.
2. Ensure the AC switch is set to “—“.
3. Press the ON button on the remote or the power button on the keypad.

19.6 Turning the Display Off

With the power on, press the OFF button on the remote or the power button on the keypad to put the LED panel in a standby mode. To turn off power completely, turn the AC switch to “O” or disconnect the AC power cord from the power outlet.

Note: The display may automatically turn off the LEDs or enter standby mode if no signal is present for a certain period of time. See the description of the Power Saving Mode setting on page 90 for more information.

19.7 Adjusting the Volume

1. Using the remote, press the vol + or vol - to increase or decrease the volume. The Up and Down keys on the remote and keypad can also be used to increase or decrease the volume.
2. Press the mute button to temporarily turn off all sound. To restore the sound, press the mute button again.

Note: The analog audio out is variable. S/PDIF is fixed.

19.8 Selecting Layouts and Input Sources

With Planar MediaPlex Plus Processing, one source at a time can be shown or multiple sources can be shown simultaneously. Multiple layout options are available and can be selected from the Inputs and Views Menu (see page 81). Once a layout has been designated, sources can be assigned to each of the zones in the layout. The selection of sources must be made one at a time by assigning a current zone. To select the current zone, navigate through the on-screen menu (see page 81). Alternatively, use the remote or keypad as described next.

Remote

Press the Zone 1, Zone 2, Zone 3, or Zone 4 buttons on the remote. After selecting the desired zone, press the source button (DP, HDMI 1, HDMI 2, HDMI 3, or HDMI 4). This action will also select the active audio source.

For example, to change Zone 3 to DP, press the Zone 3 button and then press the DP button.

Keypad

Press the SRC/Source button. The input source will be toggled sequentially.

Note: Sources will toggle through the current zone, or last zone to be modified. Current zones can only be re-assigned in the on-screen menu.

19.9 Navigating Through the Menus

1. With the power on, press MENU. The MAIN menu appears.

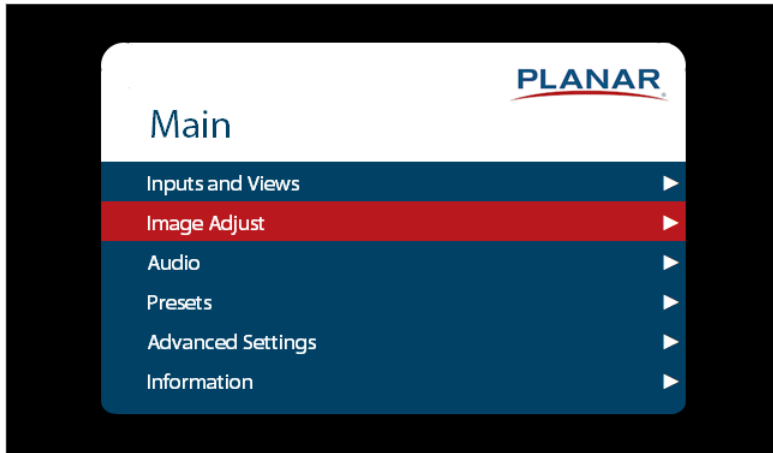

2. Within the menu, use ▲, ▼, ◀, ▶, and ENTER to navigate through the menus and adjust options.
3. Press PREV on the remote control, or MENU on the keypad, to return to the previous menu. To exit the menu system, press MENU on the remote control, or continue to press menu on the keypad until the main menu is reached.

20. Inputs and Views Menu

This menu shows how the sources will be laid out on the screen based on the current Multi-Source View and Advanced Layouts selections.

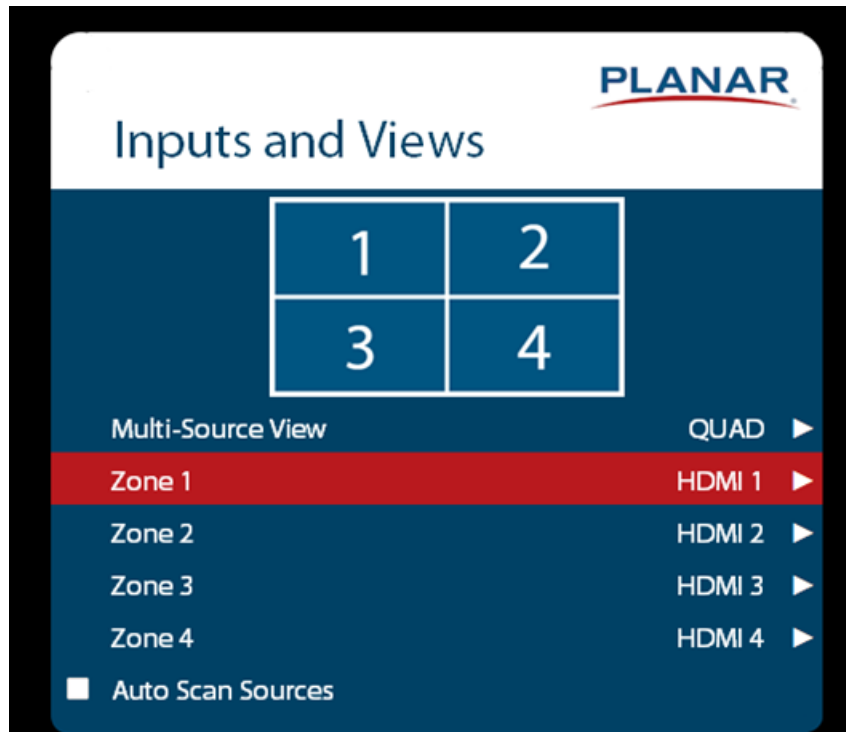

Multi-Source View

- Select the Multi-Source View mode
- **Options:** Single View, Dual View, Triple View, Quad View, PiP, Advanced Layouts;
Default: Single
- **Note:** For the Advanced Layouts submenu, refer to the Advanced Layouts Submenu on page 82.
- **Note:** URL122 does not support 4K/60Hz in multi-source view.
- **Note:** Only one HDCP 2.2 source can be displayed at a time. If HDMI 1 and HDMI 2 are both being shown on the display at the same time, only HDMI 1 will support HDCP 2.2 content.
- **Note:** DP-OUT can only transmit the content from DP IN. It cannot transmit the content from any HDMI Input.

Zone 1

- Select the source displayed in Zone 1
- **Options:** HDMI 1, HDMI 2, HDMI 3, HDMI 4, DP; **Default:** HDMI 1

Zone 2

- Select the source displayed in Zone 2
- **Options:** HDMI 1, HDMI 2, HDMI 3, HDMI 4, DP; **Default:** HDMI 2

Zone 3

- Select the source displayed in Zone 3
- **Options:** HDMI 1, HDMI 2, HDMI 3, HDMI 4, DP; **Default:** HDMI 3

Zone 4

- Select the source displayed in Zone 4
- **Options:** HDMI 1, HDMI 2, HDMI 3, HDMI 4, DP; **Default:** HDMI 4

Zone 1 Secondary

- Second input to scan when Auto Scan Sources is set to **Failover**
- **Options:** HDMI 1, HDMI 2, HDMI 3, HDMI 4, DP; **Default:** HDMI 1

Auto Scan Sources

- Select whether the display will automatically scan for a valid source on any input or zone that does not have a source currently displayed.
- **Options:** Off, On, Failover; **Default:** Off
- **Off:** Display will stay on current selection of inputs.
- **On:** Scanning will begin on the currently selected source and move sequentially through the inputs in the order listed below – stopping once a valid source is obtained.
 - **Search Order:** HDMI 1, HDMI 2, HDMI 3, HDMI 4, DP
- **Failover:** Display will scan selected Zone 1 input and selected Zone 1 Secondary input for a valid source. Only applies to Zone 1.

Advanced Layouts Submenu

This submenu defines the layouts for each multi-source view type.

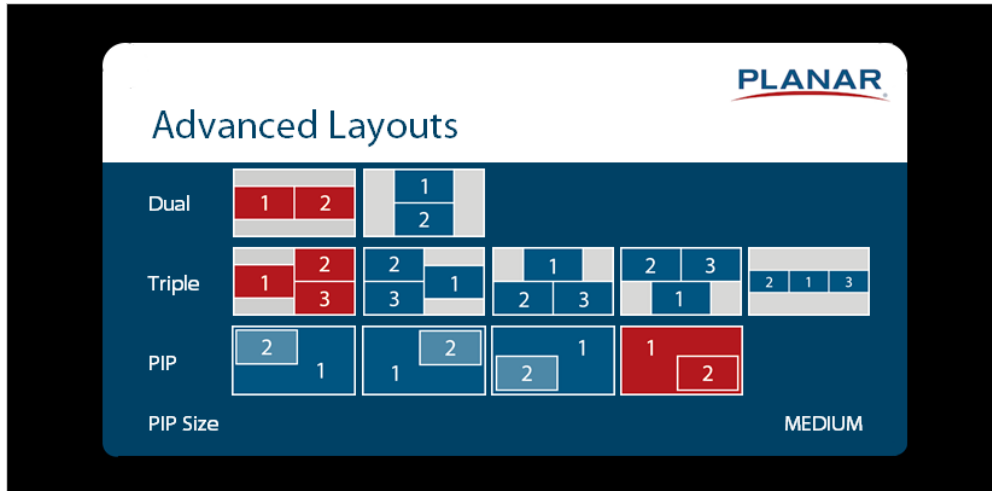

Dual

- Select from two dual source layout options. The layout in orange will be the active layout displayed when the Multi-Source View is set to Dual.

Triple

- Select from five triple source layout options. The layout in orange will be the active layout displayed when the Multi-Source View is set to Triple.

PIP

- Select from four PiP (Picture-in-Picture) layouts. The layout in orange will be the active layout displayed when the Multi-Source View is set to PiP.

PIP Size

- Select the size of the PiP (Picture-in-Picture) window.

Note: The actual proportions of the source windows will vary depending on the incoming source resolution and image settings. The image settings that influence proportions include Aspect Ratio and Content Rotation (see section 20.1 on page 84).

20.1 Image Adjust Menu

This menu is used for making common image adjustments for the current zone.

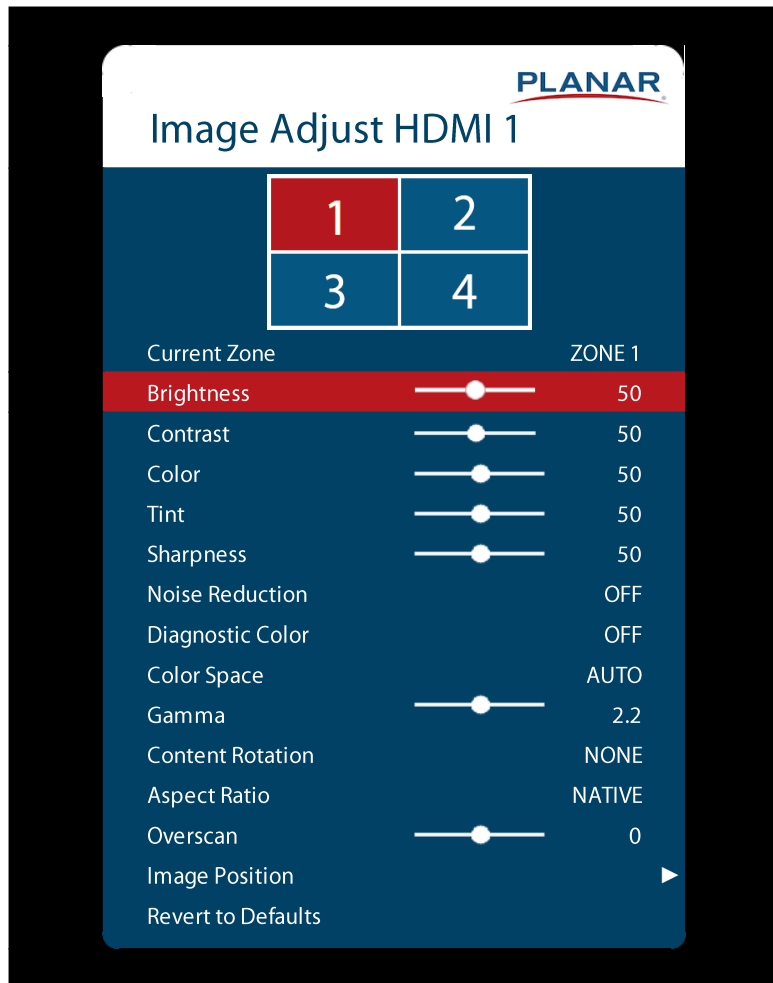

Current Zone

- The zone that is currently being adjusted. All of the settings in this menu are saved per input. The zone's corresponding input source is shown in the title bar, and the graphic beneath that shows which zone is being adjusted in the current Multi-Source View mode and Advanced Layout setting (if applicable).
- The current zone can be changed via the menu or by using the ZONE 1-4 keys on the remote control.
- **Note:** Changing the Current Zone setting via the ZONE 1-4 keys also changes the Audio Select setting.

Brightness

- Adjust the black level of the image
- **Range:** 0~100; **Default:** 50

Contrast

- Adjust the white level of the image
- **Range:** 0~100; **Default:** 50

Color

- Adjust the saturation of the image
- **Range:** 0~100; **Default:** 50

Tint

- Adjust the hue of the image
- **Range:** 0~100; **Default:** 50

Sharpness

- Adjust the sharpness of the image. Higher numbers are sharper
- **Range:** 0~10; **Default:** 5

Noise Reduction

- Turn on noise reduction processing
- **Options:** Off, Low, Medium, High; **Default:** Off

Diagnostic Color

- Set the image to monochrome. This setting is for use in adjustments to a test pattern and is not stored.
- **Options:** Off, Red, Green, Blue; **Default:** Off

Color Space

- Set the color space of the image
- **Options:** REC601, REC709, RGB, RGB Video, Auto; **Default:** Auto

Gamma

- Set the gamma of the image
- **Options:** 1.5, 1.55, 1.6, 1.65, 1.7, 1.75, 1.8, 1.85, 1.9, 1.95, 2.0, 2.05, 2.1, 2.15, 2.2, 2.25, 2.3, 2.35, 2.4, 2.45, 2.5, 2.55, 2.6, 2.65, 2.7, 2.75, 2.8.
- **Default:** 2.2

Content Rotation

- Rotate the image on the display
- **Options:** None, 90, 180, 270; **Default:** None

Aspect Ratio

- Set how the source is treated when the aspect ratio of the input is different than the aspect ratio of the zone it is in. If the image does not fill the zone completely, the extra margins are black.
- **Options:** Auto, 16:9, 4:3, Fill Screen, Native, Letterbox; **Default:** Auto

Overscan

- Set the percentage of the image to remove from each edge
- **Range:** 0~20; **Default:** 0

Image Position

- Move the image horizontally or vertically. The amount to move is measured in input pixels.
- **Range:** -1000~1000; **Default:** 0

Revert to Defaults

- Reset all settings in the Image Adjust menu to their factory defaults for the current zone only

20.2 Audio Menu

This menu provides the ability to make audio adjustments to the selected zone.

Note: Volume, Bass, Treble and Balance do not apply to the S/PDIF output.

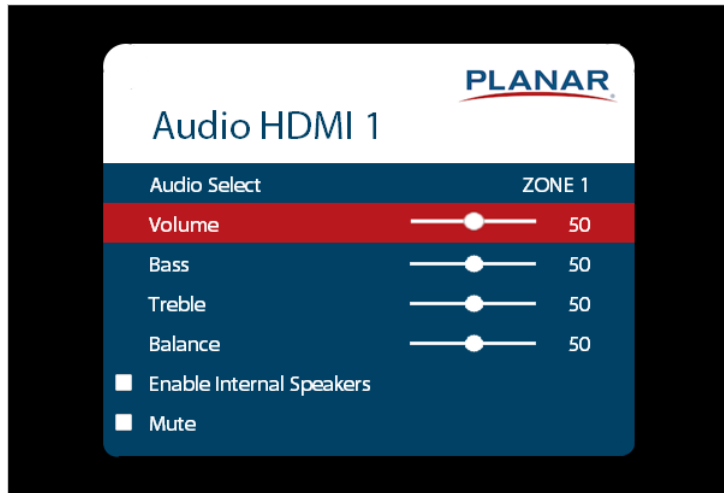

Audio Select

- The zone that is currently being adjusted and whose audio is being played. The zone's corresponding input source is shown in the title bar.
- **Options:** Zone 1, Zone 2, Zone 3, Zone 4; **Default:** Zone 1
- **Note:** Changing the Audio Select setting via the ZONE 1-4 keys on the remote also changes the Current Zone setting.

Volume

- Set the volume of the audio
- **Range:** 0~100; **Default:** 50

Bass

- Set the bass level
- **Range:** 0~100; **Default:** 50
- **Note:** This setting applies only to the internal speakers, and cannot be adjusted for the Line Out connector.

Treble

- Set the treble level
- **Range:** 0~100; **Default:** 50
- **Note:** This setting applies only to the internal speakers, and cannot be adjusted for the Line Out connector.

Balance

- Set the audio balance
- **Range:** 0~100; **Default:** 50

Enable Internal Speakers

- Disable or enable the built-in speakers
- **Options:** On, Off; **Default:** On

Mute

- Mute or unmute the audio
- **Options:** On or Off; **Default:** Off

20.3 Presets Menu

This menu provides the ability to save Inputs and Views settings, Image Adjust settings, Audio settings, and the Intensity setting. The Tiling settings are also available. Up to 10 presets can be saved using this menu (more can be saved via the serial command interface). If a preset is saved, it will appear as “Preset 1”, “Preset 2”, and so on. If it is not saved, it will appear as “<Empty>”.



Recall

- Apply the setup from the selected preset
- **Range:** Preset 1~Preset 10

Save

- Save the current setup for later recall
- **Range:** Preset 1~Preset 10

Delete

- Delete the selected preset
- **Range:** Preset 1~Preset 10

20.4 Advanced Settings Menu

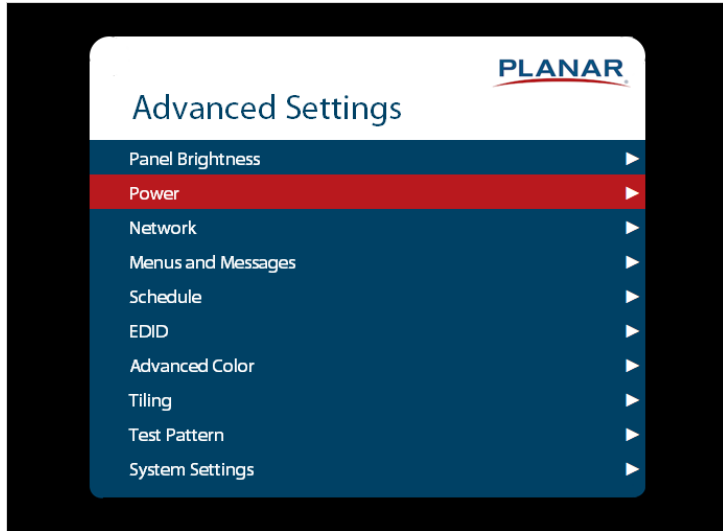

Panel Brightness Submenu



Intensity

- Set the intensity of the LED display.
- **Range:** 0~100; **Default:** 75

Power Submenu

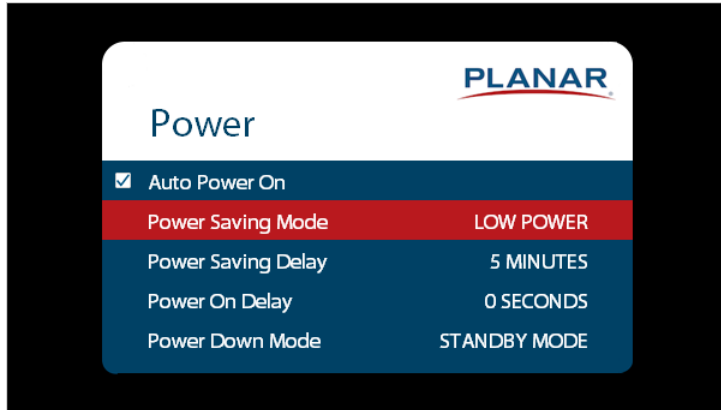

Auto Power On

- If set to On, the display will automatically leave standby after AC power is applied
- **Options:** On, Off; **Default:** Off

Power Saving Mode

- Set the action to take if there is no signal detected after the period of time specified by the **Power Saving Delay** setting
- **Options:** Disabled, Power Down, Wake on Signal; **Default:** Disabled
 - **Disabled:** Once powered on, the display will remain on even if no signal is present.
 - **Power Down:** The display will enter a standby state specified by the **Power Down Mode** setting.
 - **Wake On Signal:** The display will enter a standby sleep mode if no signal is detected. The display will wake when signal is restored.
 - **Note:** When signal is restored, a 10-15 second wait is typical to have an image displayed.
 - **Note:** The display must be allowed to enter sleep mode due to lack of signal for **Wake On Signal** to take effect. Sending an OFF command via Keypad, IR, CEC, RS232 or LAN will bypass **Wake On Signal** detection, and the display will enter the power state specified in the **Power Down Mode** setting.
 - **Note:** If **Auto Scan Sources** is enabled in the **Inputs and Views** menu, the display will sequentially scan all inputs before entering sleep mode. The display will leave sleep mode when a signal is detected on any input.
 - **Note:** If **Auto Scan Sources** is disabled in the **Inputs and Views** menu, the display leave sleep mode only when a signal is detected on the last selected input.
 - **Note:** When **Wake On Signal** is selected, the LAN port and **Remote Monitoring** web interface will remain accessible after the display enters sleep mode.

Power Saving Delay

- Sets the amount of time before initiating the standby state specified in **Power Saving Mode** when no signal is present
- **Options:** 1 Minute, 5 Minutes, 15 Minutes, 30 Minutes, 60 Minutes; **Default:** 5 Minutes

Power On Delay

- Sets the amount of time to delay between an ON command being received and the display leaving standby. This can be useful when multiple displays are on the same electrical circuit, and it is beneficial to avoid all displays leaving standby simultaneously, causing a large inrush of current.
- **Options:** 0-10 seconds, in 0.1 second increments; **Default:** 0 seconds

Power Down Mode

- Set the action to take when the display enters standby
- **Options:** Standby Mode, Networked Standby Mode, Fast Startup; **Default:** Standby Mode
- **Standby Mode:** The lowest power standby setting. CEC, LAN, DB9 RS232, and USB communication are disabled. IR, Keypad connector will remain active.
 - **Note:** To remove display from standby with the IR remote or keypad, IR Remote Lock or Keypad Lock must be disabled.
 - **Note:** The Turn On action in the Schedule feature will not work if the **Power Down Mode** setting is set to **Standby Mode**. To allow the Turn On action to occur, set **Power Down Mode** to **Networked Standby Mode** or **Fast Startup**.
- **Networked Standby Mode:** The display will enter a low power standby state with LAN, DB9 RS232, USB and IR communications active.
- **Fast Startup:** The display will enter a standby state with partially reduced power, allowing for 3-5 second wait between an ON command being sent, and image being displayed. IR, Keypad, CEC, LAN, DB9 RS232, and USB communication will remain active.

Network Submenu

The default static IP values are:

- IP Address: 192.168.12.12
- Subnet Mask: 255.255.255.0
- Default Gateway: 192.168.12.1

The static IP settings programmed will be used if a DHCP server cannot be found.

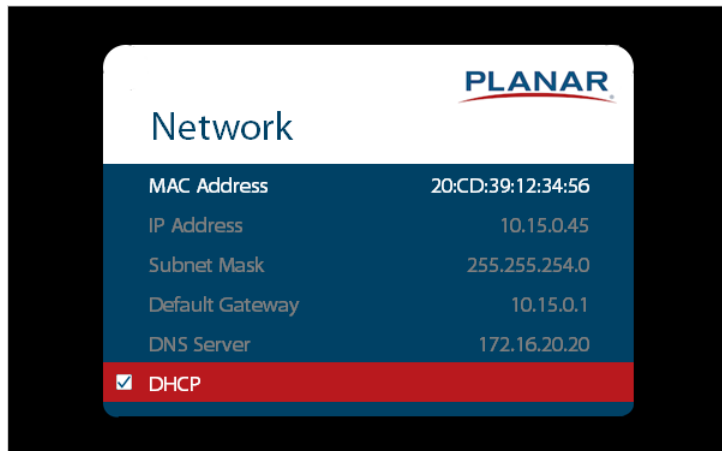

MAC Address

- The MAC address of the system

IP Address

- The current network address. The number keys on the remote can be used to enter this information.

Subnet Mask

- The current subnet mask. The number keys on the remote can be used to enter this information.

Default Gateway

- The current default gateway. The number keys on the remote can be used to enter this information.

DNS Server

- The current DNS server. The number keys on the remote can be used to enter this information.
- **Note:** The specified DNS server is used when Use Network Time is checked for the Set Date and Time setting.

DHCP

- Turn DHCP on or off
- **Options:** On, Off; **Default:** On

Menus and Messages Submenu

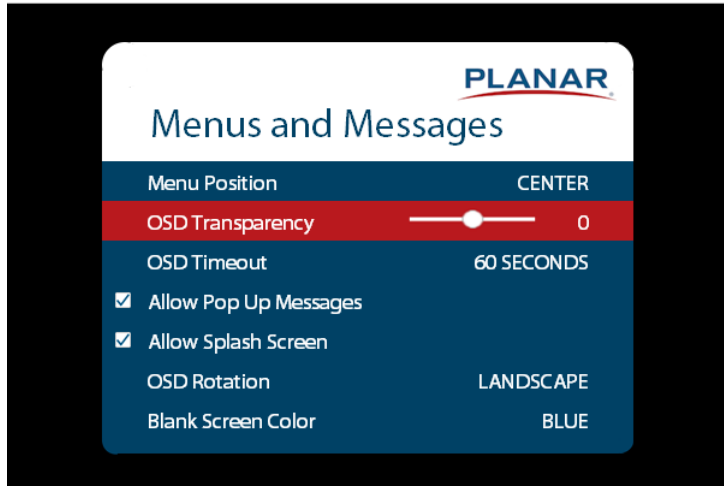

Menu Position

- Move the OSD menu to a different location on the screen
- **Options:** Center, Upper Left, Upper Right, Lower Left, Lower Right; **Default:** Center

OSD Transparency

- Set the transparency of the OSD so that the image behind it can be seen. Higher values mean greater transparency.
- **Range:** 0~5; **Default:** 0

OSD Timeout

- Set the amount of time in seconds since the last keypress before the OSD menu automatically closes. If set to Off, the menu never automatically closes.
- **Options:** Off, 10 Seconds, 30 Seconds, 60 Seconds, 120 Seconds, 240 Seconds; **Default:** 60 Seconds

Allow Pop Up Messages

- Suppress messages that pop up automatically. When set to No, the source status message and the volume slider bar will not be displayed.
- **Options:** Yes or No; **Default:** Yes

Allow Splash Screen

- Enable or disable the splash screen during startup
- **Options:** Enable or Disable; **Default:** Enable

OSD Rotation

- Rotate the OSD menu so that it is readable if the display is mounted in portrait orientation
- **Options:** Landscape or Portrait; **Default:** Landscape

Blank Screen Color

- Select the color to display when there is no signal in a zone
- **Options:** Black, White, Gray, Red, Green, Blue, Cyan, Magenta, Yellow
- **Default:** Black

Schedule Submenu

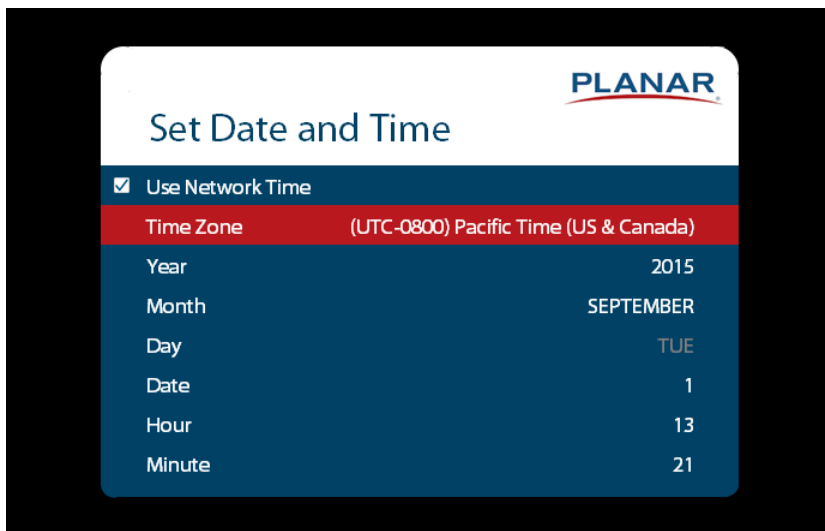
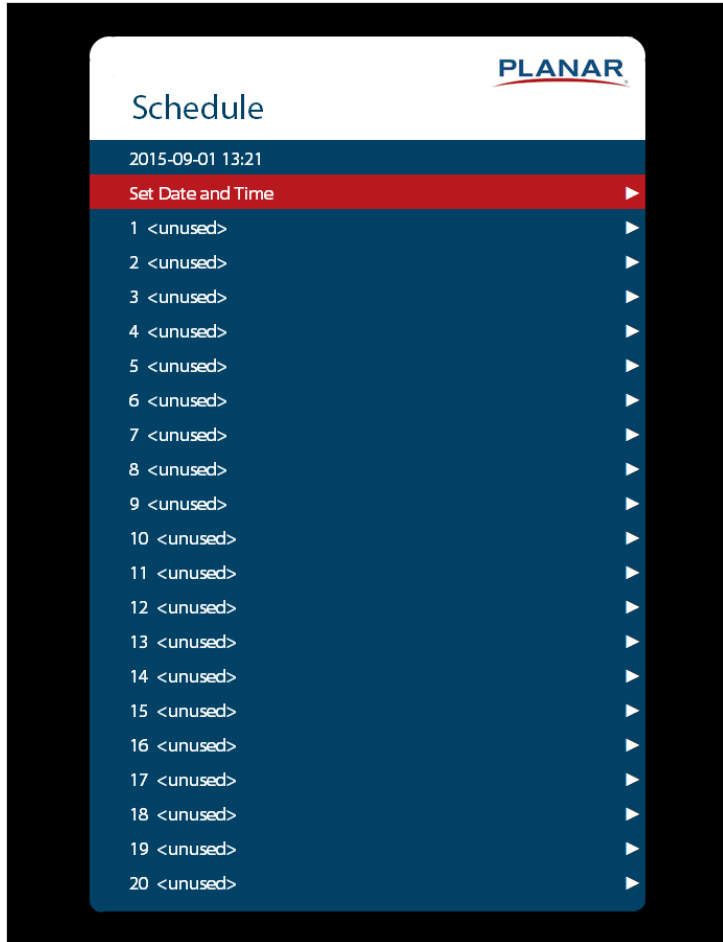

Set Date and Time

- Set the internal system clock. If Use Network Time is unchecked, the following settings can be individually set: Time Zone, Year, Month, Day, Date, Hour, and Minute.
- **Note:** If Use Network Time is checked and DHCP is unchecked, the display will be unable to obtain the network time unless a DNS server is programmed. This is done via the DNS Server setting in the Network menu or the serial command interface.

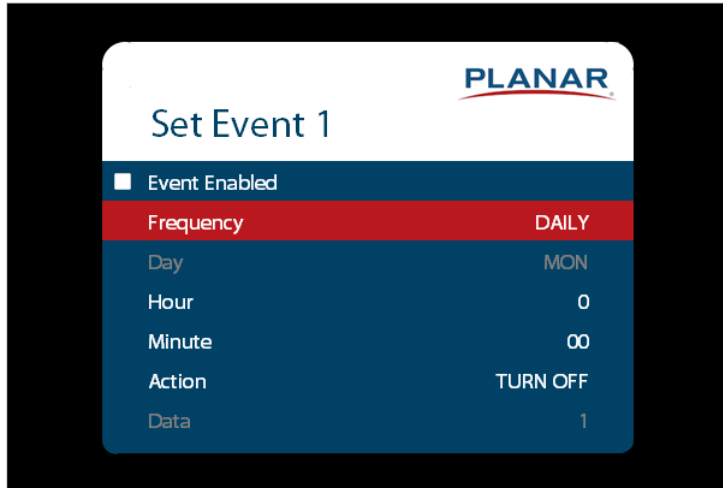

Set Event 1~Event 20

- **Event Enabled:** Turns on the event. If disabled, the settings are saved so that the event can be re-enabled.
- **Frequency:** The frequency of the event. Options are Daily, Weekly, Weekdays, Weekends.
- **Action:** The action to take for the event. Options are Turn On, Turn Off, Recall, Panel Brightness.
 - **Note:** The Turn On action will not work if the **Power Down Mode** setting is set to **Standby Mode**. To allow the Turn On action to occur, set **Power Down Mode** to **Networked Standby Mode** or **Fast Startup**.
- **Data:** The preset to recall when the Action is set to Recall, or the intensity setting when the Action is set to Panel Brightness.

EDID Submenu

This menu specifies the EDID format and preferred timing for the selected connector.

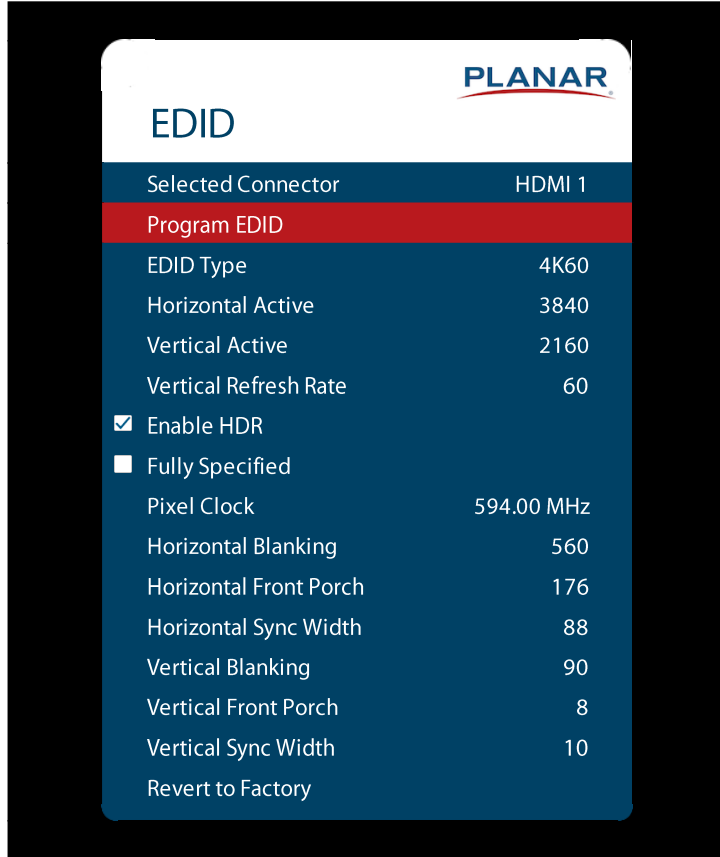

Selected Connector

- Set which connector is used
- **Options:** HDMI 1, HDMI 2, HDMI 3, HDMI 4, DP, All

Program EDID

- Program the EDID information for the selected connector based on the selections in the EDID submenu

EDID Type

- Set the EDID type to determine the base EDID used for the current connector:
- 4K60 selects an EDID format compliant with HDMI 2.0 and DP 1.2
- 4K30 selects an EDID format compliant with HDMI 1.4b and DP 1.1
- 1080P selects an EDID format compliant with HDMI 1.3 and DP 1.1
- **Options:** 4K60, 4K30, 1080P

Horizontal Active

- The number of active pixels in a line
- **Range:** 0~4095

Vertical Active

- The number of active lines in a field
- **Range:** 0~4095

Vertical Refresh Rate

- The number of fields per second rounded to the nearest Hz
- **Range:** 0~120

Enable HDR

- Indicate to the source that HDR content is supported
- **Options:** On, Off; **Default:** On
- **Note:** HDR compatible inputs are HDMI 1, HDMI 2 and the OPS.
- **Note:** Displaying HDR content requires an HDR compatible source and HDR encoded content.
- **Note:** HDR sources connected via HDMI require high speed (18Gbps) compatible cables

Fully Specified

- Determine how the final detailed timing is calculated. If disabled, it is calculated based on Horizontal Active, Vertical Active, and Vertical Refresh Rate values. If enabled, it is calculated based on all of the EDID values except for Vertical Refresh Rate.
- **Options:** Disabled, Enabled
- **Note:** This setting should only be enabled by advanced users.

Pixel Clock

- The value of the pixel clock, in megahertz
- **Range:** 0~600.00, in 0.01 increments

Horizontal Blanking

- The number of non-active pixel clocks in a line
- **Range:** 0~1023

Horizontal Front Porch

- The number of pixel clocks in the horizontal front porch
- **Range:** 0~1023

Horizontal Sync Width

- The number of pixel clocks in the horizontal sync pulse
- **Range:** 0~255

Vertical Blanking

- The number of non-active lines in a field
- **Range:** 0~255

Vertical Front Porch

- The number of line times in the vertical front porch
- **Range:** 0~255

Vertical Sync Width

- The number of line times in the vertical sync
- **Range:** 0~255

Revert to Factory

- Reset the EDID type and timings to the default values for the selected connector

Tiling Submenu

This menu contains controls for using multiple Planar UltraRes L Series displays in a tiled configuration. This is useful when trying to display one image across multiple displays. In addition to setting up the width and height of the tiled wall, each display must have its position within the tiled wall properly selected. Refer to the diagrams below for example setting values in a 3 x 4 tiled wall.

Note: When using the Content Rotation feature, the Tiling settings must be adjusted differently in order to display the image properly. Refer to the examples below.

Example 1: 0 Degree Rotation, Wall Width = 3, Wall Height = 4

Unit Row 1 Unit Column 1	Unit Row 1 Unit Column 2	Unit Row 1 Unit Column 3
Unit Row 2 Unit Column 1	Unit Row 2 Unit Column 2	Unit Row 2 Unit Column 3
Unit Row 3 Unit Column 1	Unit Row 3 Unit Column 2	Unit Row 3 Unit Column 3
Unit Row 4 Unit Column 1	Unit Row 4 Unit Column 2	Unit Row 4 Unit Column 3



Example 2: 180 Degree Rotation, Wall Width = 3, Wall Height = 4

Unit Row 4 Unit Column 3	Unit Row 4 Unit Column 2	Unit Row 4 Unit Column 1
Unit Row 3 Unit Column 3	Unit Row 3 Unit Column 2	Unit Row 3 Unit Column 1
Unit Row 2 Unit Column 3	Unit Row 2 Unit Column 2	Unit Row 2 Unit Column 1
Unit Row 1 Unit Column 3	Unit Row 1 Unit Column 2	Unit Row 1 Unit Column 1



Example 3: 90 Degree Rotation, Wall Width = 4, Wall Height = 3

Unit Row 3 Unit Column 1	Unit Row 2 Unit Column 1	Unit Row 1 Unit Column 1
Unit Row 3 Unit Column 2	Unit Row 2 Unit Column 2	Unit Row 1 Unit Column 2
Unit Row 3 Unit Column 3	Unit Row 2 Unit Column 3	Unit Row 1 Unit Column 3
Unit Row 3 Unit Column 4	Unit Row 2 Unit Column 4	Unit Row 1 Unit Column 4



Example 4: 270 Degree Rotation, Wall Width = 4, Wall Height = 3

Unit Row 1 Unit Column 4	Unit Row 2 Unit Column 4	Unit Row 3 Unit Column 4
Unit Row 1 Unit Column 3	Unit Row 2 Unit Column 3	Unit Row 3 Unit Column 3
Unit Row 1 Unit Column 2	Unit Row 2 Unit Column 2	Unit Row 3 Unit Column 2
Unit Row 1 Unit Column 1	Unit Row 2 Unit Column 1	Unit Row 3 Unit Column 1





Tiling Enabled

- When enabled, the tiling parameters in the menu are used
- **Options:** Disable, Enable; **Default:** Disable

Wall Width, Wall Height

- Select the width and height of the tiled wall
- **Default:** Width=1, Height=1

Unit Column, Unit Row

- Selects the location of the current display within the tiled wall
- **Default:** Column=1, Row=1

Frame Compensation

- When enabled, the image is scaled to compensate for the width of the display's bezel, using the Frame Width and Frame Height parameters. See "Frame Compensation Examples" on page 105.
- **Options:** Disable, Enable; **Default:** Disable

Frame Width, Frame Height

- Selects how many lines/pixels are removed from the image to compensate for the display's bezel

Frame Compensation Examples

Below are examples with the Frame Compensation feature enabled (left) and disabled (right). Note that the eagle's eye is noticeably different when Frame Compensation is disabled.

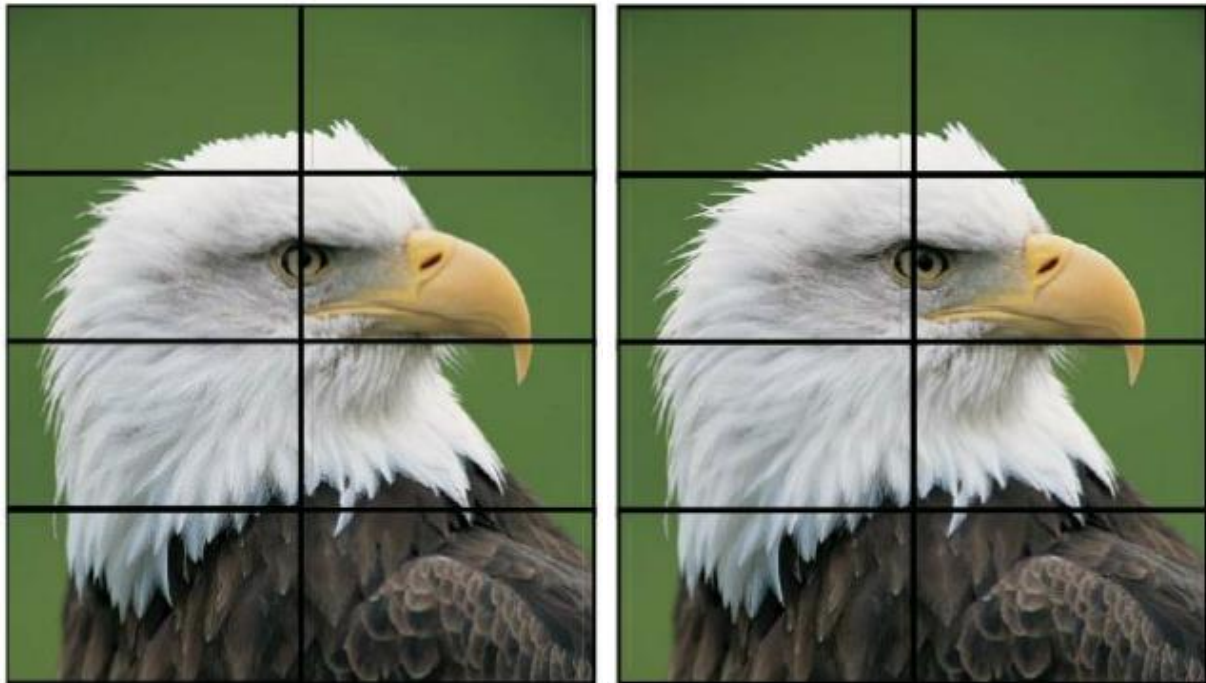

Test Patterns Submenu

This menu selects a test pattern to show on the display for diagnostic purposes.

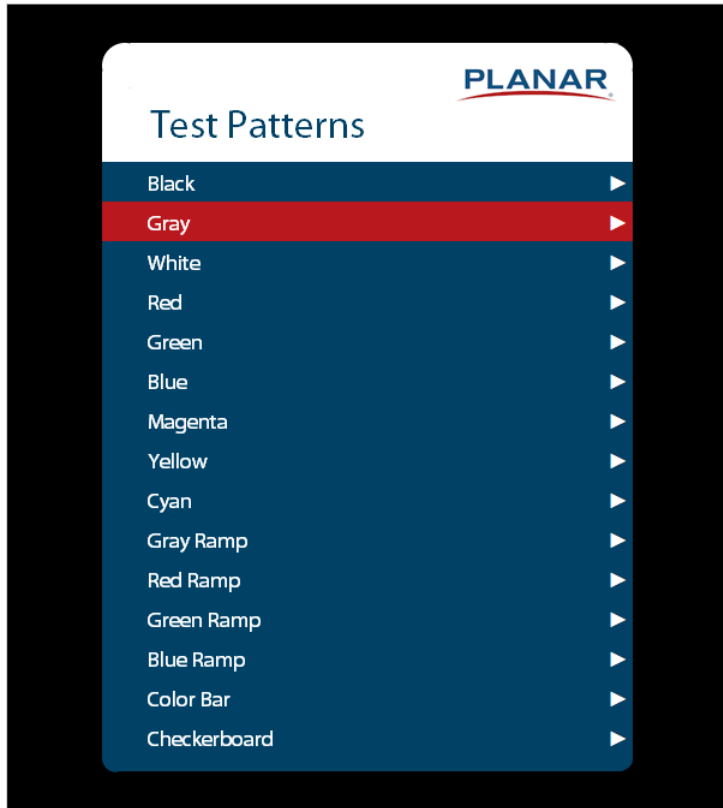

Test Patterns

- **Options:** Black, Gray, White, Red, Green, Blue, Magenta, Yellow, Cyan, Gray Ramp, Red Ramp, Blue Ramp, Color Bar, Checkerboard

System Settings Submenu

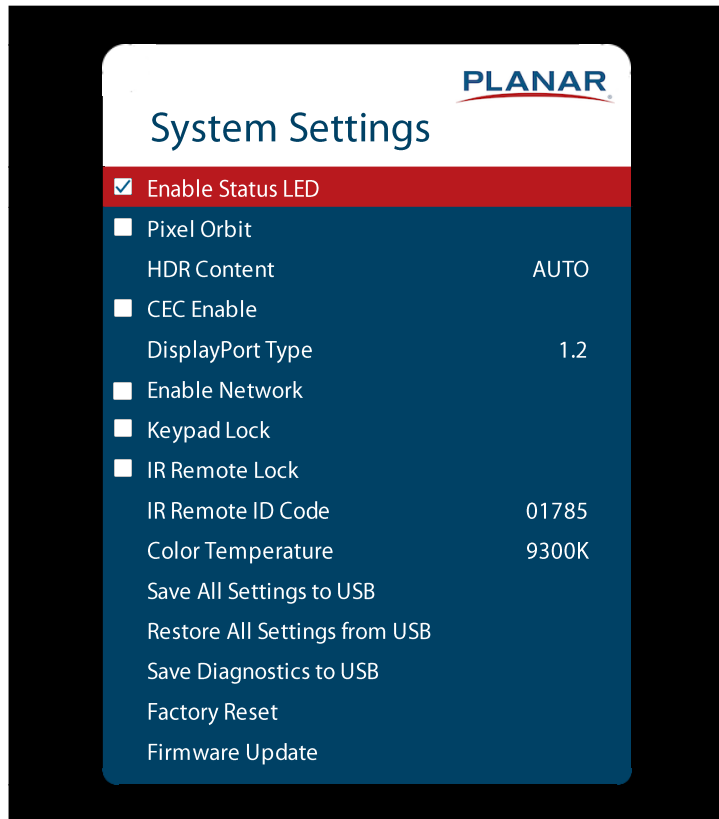

Enable Status LED

- When enabled, the status LEDs on the back of the display behave as indicated on page 71. When disabled, the status LEDs are always turned off.
- **Options:** Disable, Enable; **Default:** Enable

Pixel Orbit

- Create slight frame motion to help avoid image retention
- **Options:** Enable, Disable; **Default:** Disable

CEC Enable

- Enables HDMI-CEC (Consumer Electronics Control) with compatible external devices
- **Options:** On, Off; **Default:** Off

The CEC commands listed in the tables below are implemented:

Command	Value
Image View On	0x04
Text View On	0x0D
Standby	0x36
User Control Pressed	0x44
Routing Change	0x80
Active Source	0x82
Give Physical Address	0x83
Report Physical Address	0x84
Request Active Source	0x85
Give Device Power Status	0x8F
Report Power Status	0x90
Inactive Source	0x9D
CEC Version	0x9E
Get CEC Version	0x9F
Give Features	0xA5
Report Features	0xA6

DisplayPort Type

- Set the version of DisplayPort that is used by the system
- **Options:** 1.1, 1.2; **Default:** 1.2

Keypad Lock

- Lock or unlock the keypad. When it is enabled, all keypad presses will be ignored.
- **Options:** Enable, Disable; **Default:** Disable

IR Remote Lock

- Lock or unlock the remote control. When it is enabled, all remote control presses will be ignored.
- **Options:** Enable, Disable; **Default:** Disable

IR Remote ID Code

- Selects the IR remote code set accepted by the display. See “Using the Remote Control” on page 72.
- **Options:** 00000-65535; **Default:** 01785

Color Temperature

- Set the color temperature of the image
- **Options:** 3200K, 6500K, 9300K, 12000; **Default:** 6500K

Save All Settings to USB

- Save all settings in the display to a USB flash drive. The saved file will be named Planar-settings.bin and will be saved in the root folder of the USB flash drive.
- **Note:** A USB flash drive must be inserted into the USB-A connector prior to using this feature. The USB flash drive must be formatted as FAT32. This feature will not work with the NTFS file system.

Restore All Settings from USB

- Restores all settings in the display from a USB flash drive. The settings file must be named Planar-settings.bin and must be located in the root folder of the USB flash drive.
- **Note:** A USB flash drive must be inserted into the USB-A connector prior to using this feature. The USB flash drive must be formatted as FAT32. This feature will not work with the NTFS file system.

Save Diagnostics to USB

- Save a diagnostic report to a USB flash drive to help Planar Technical Support troubleshoot any issues. The saved file will be named Planar-diagnostics.bin and will be saved in the root folder of the USB flash drive.
- **Note:** A USB flash drive must be inserted into the USB-A connector prior to using this feature. The USB flash drive must be formatted as FAT32. This feature will not work with the NTFS file system.

Factory Reset

- Return the saved settings in a system to their factory defaults.

Firmware Update

- Update the firmware for the display. Refer to the instructions on the firmware release package for more information.

20.5 Information Menu

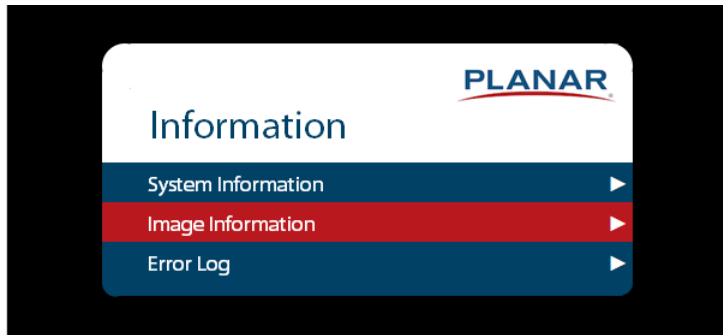

System Information Submenu

This menu displays version information for all programmable parts in the system. It also contains the model and serial number.

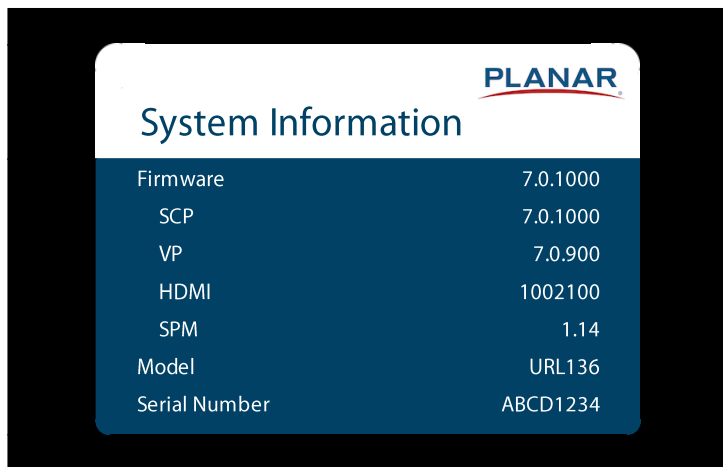
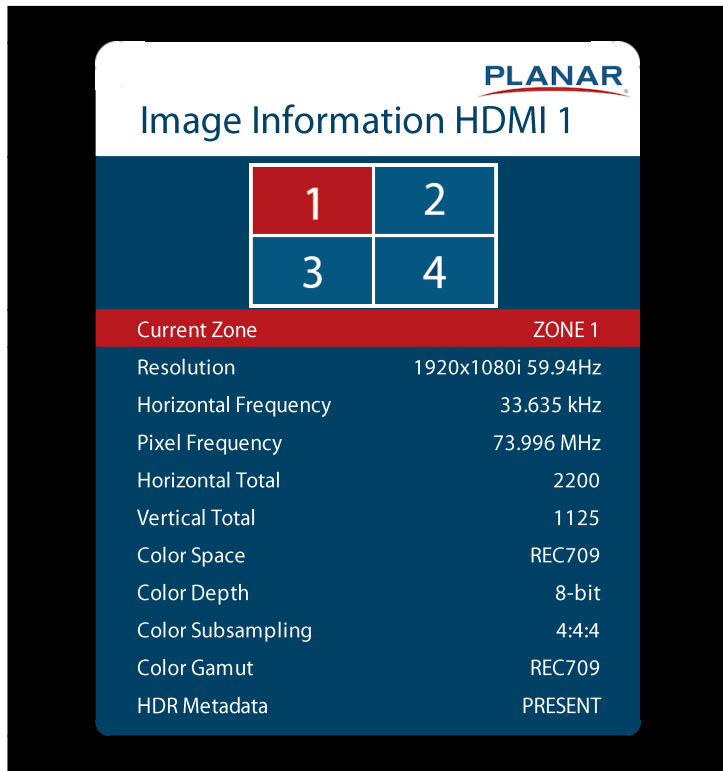

Image Information Submenu

This menu displays image details for the current zone. If more than one zone is available, the zones can be changed by setting the **Current Zone** option.



Error Log Submenu

This menu displays a chronological list of system errors that have occurred. For a list of possible errors, see "Error Codes" on page 149.

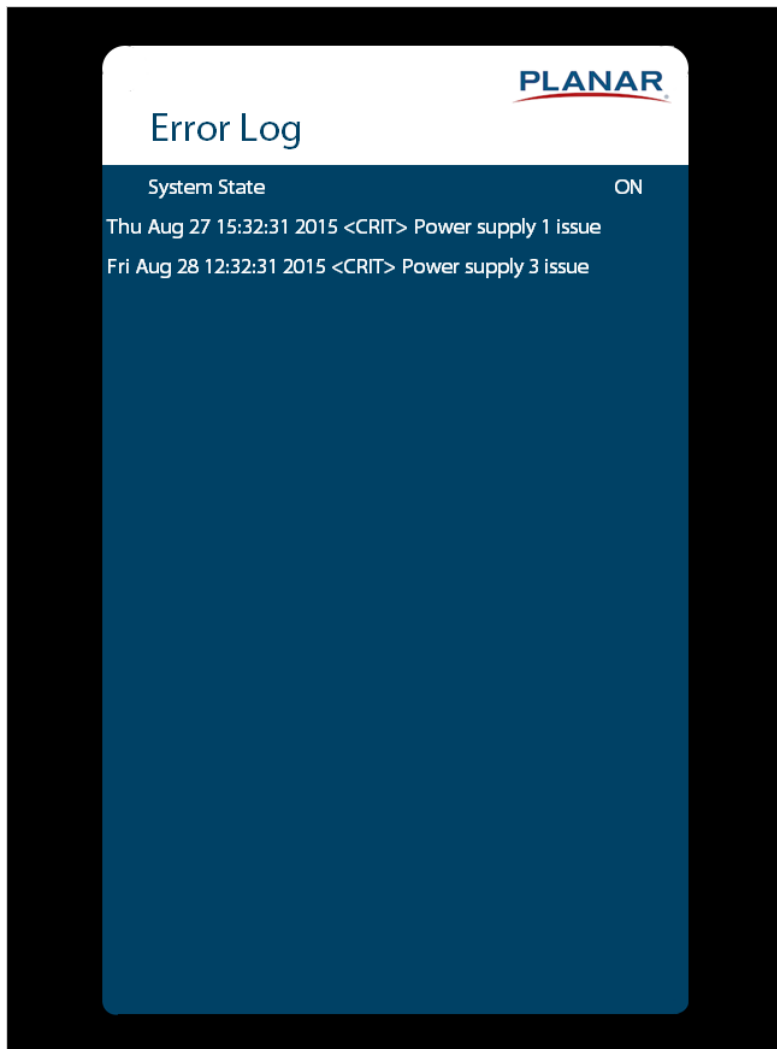

21. Using the Touch Screen

The touch screen can be used to control a Windows, Mac or Linux operating system. The Planar UltraRes L Series is HID compliant, delivering up to 10 points of touch on both Windows and Linux without a driver. Single touch only is supported for Mac operating systems. To achieve more than single touch Mac support, drivers will need to be installed, which can be found on <http://www.planar.com/support>.

Note: Ensure that the USB cable from the display to computer has been installed.

Planar UltraRes Web UI

Connect the display to the Local Area Network. Launch a web browser on a computer or mobile device that has access to the same LAN.

Enter the IP address shown in the “Network submenu” on page 92.

Because the UI is generated within the display, and not an external website, it does not carry the typical https certificate. Depending on the browser’s security settings, it may be necessary to authorize the display’s web interface.

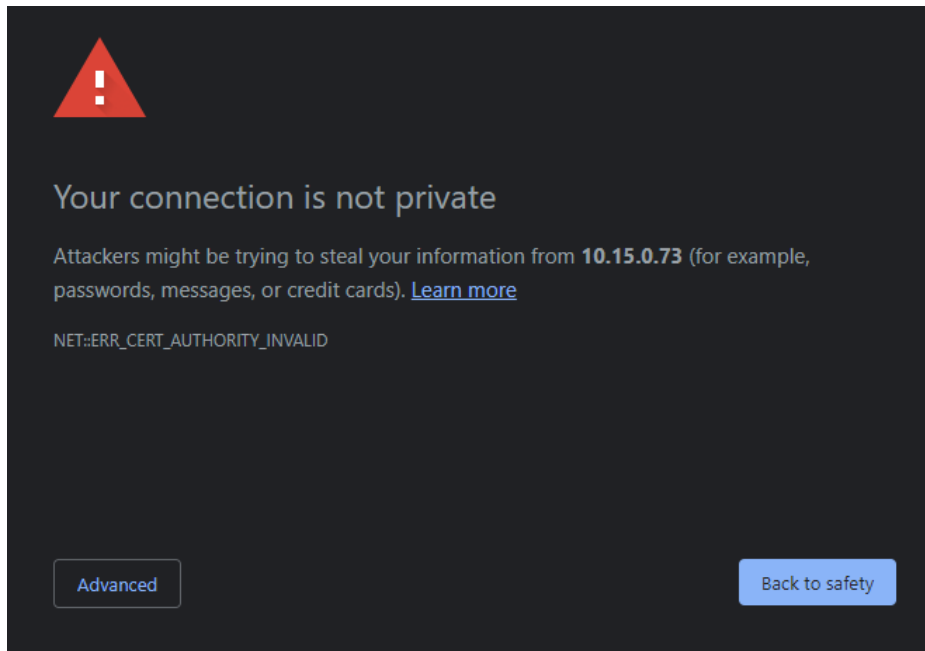

Example of a browser’s authorization screen. The authorization is found by pressing the **Advanced** button.

When a new session is started by opening a web browser window and directing it to the appropriate IP address, compatible Planar UltraRes products will display the login page to access the features within the software.

The default username is Admin. The default password is the display’s serial number.

This password may be changed after login to a more convenient password.

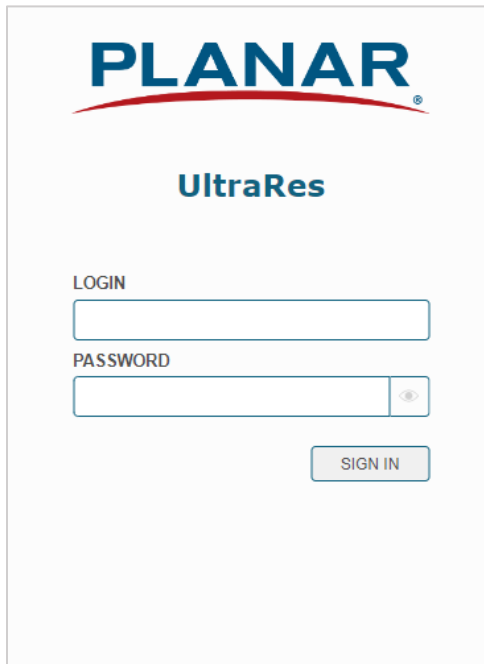

The image shows the login interface for the Planar UltraRes system. At the top is the Planar logo in blue with a red swoosh underneath. Below the logo is the text "UltraRes" in a bold, blue font. Underneath that, the word "LOGIN" is displayed. There are two input fields: the first is for the username, and the second is for the password, which includes a small eye icon to toggle visibility. A "SIGN IN" button is located below the password field.

If successful, the Remote Monitoring Interface will be shown.

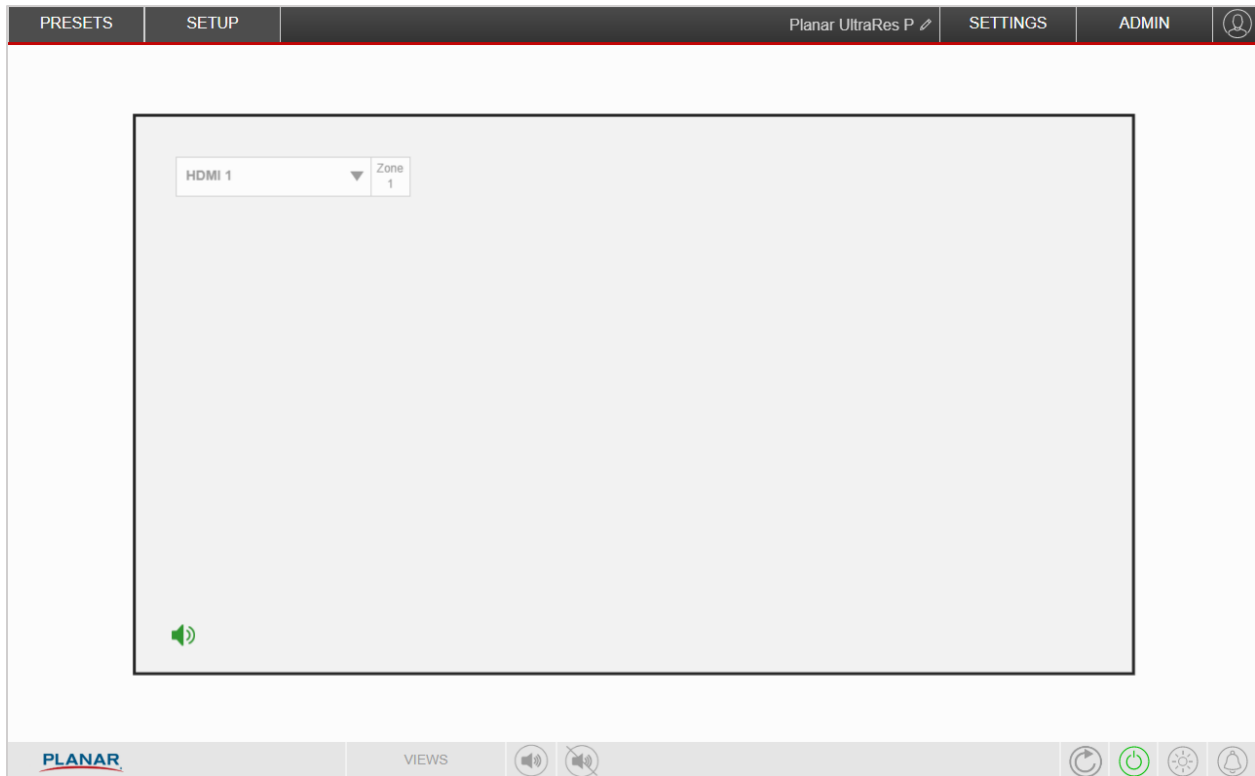

Note: If the password needs to be reset, the recovery method is connected by serial and send a `PASSWORD.SET="newpassword"` command, with the new password enclosed in double-quotes. `PASSWORD.SET` commands are not accepted over network, only direct serial connection. Alternatively, a factory reset will restore the password to the serial number.

22. UltraRes Web UI Home Screen

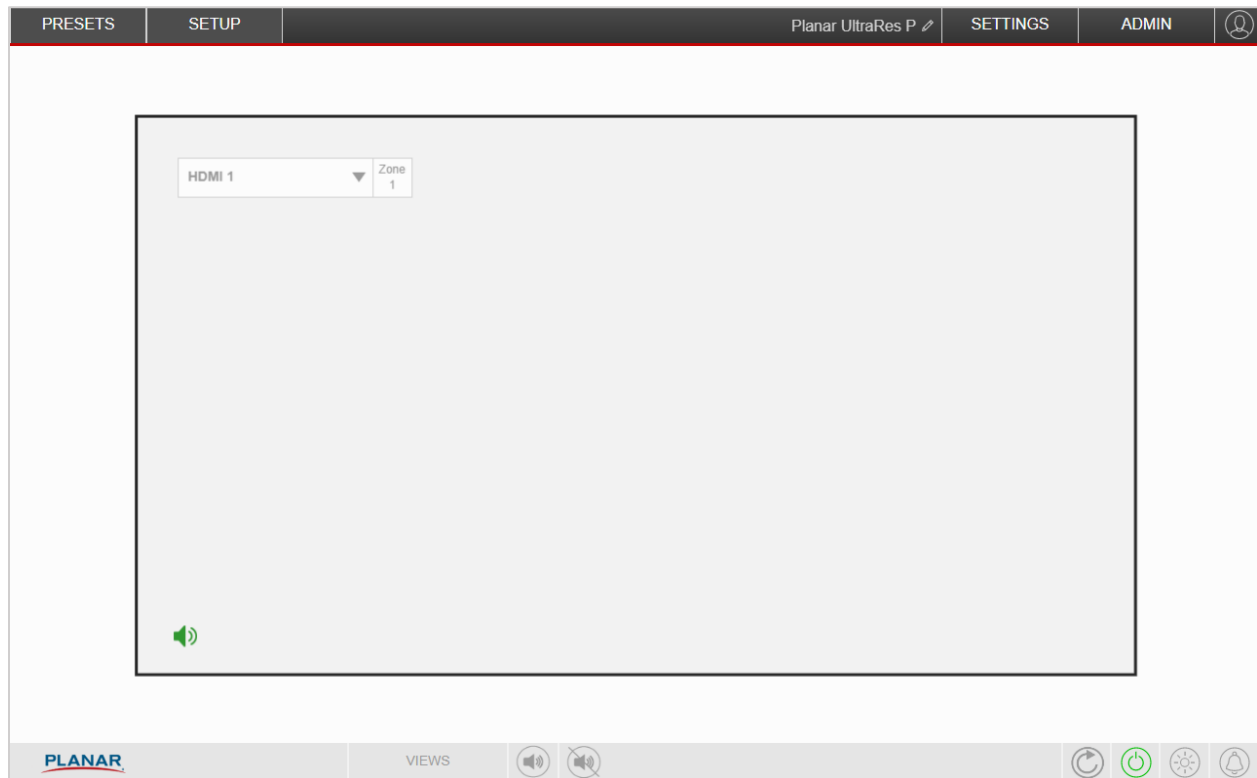

The Planar UltraRes Web UI consists of a top bar with drop-down menus, a canvas representing the display's current layout, and a bottom bar with pop-up menus.

Note: Depending on the device or browser settings, the proportions of the UI will vary. If the Planar UltraRes Web UI detects a mobile device, the layout will change to the proportionate interface, and menu items may be relocated.

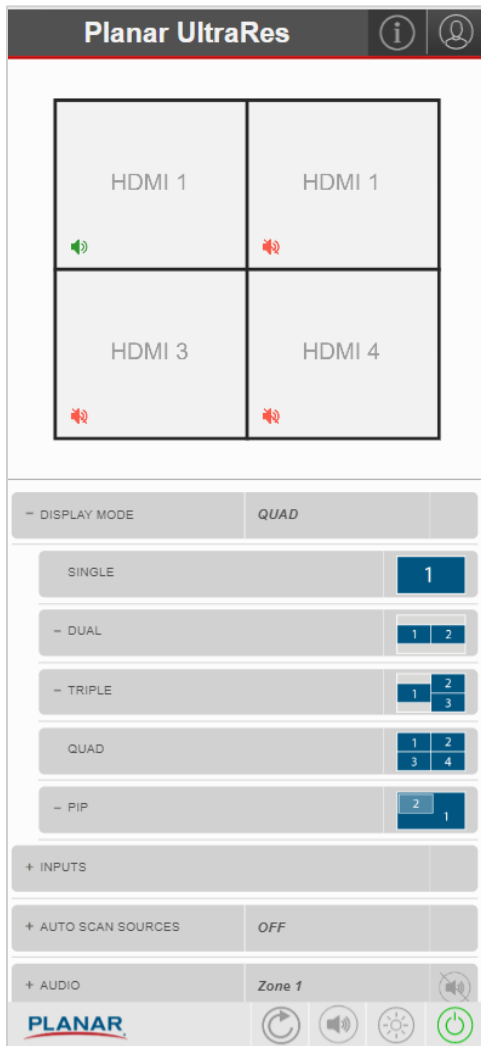

Example of a mobile interface

The top bar of the user interface contains the drop-down menus for Presets, Setup, Settings and Admin.



The avatar icon contains a drop-down menu to show who is currently logged in. The display name is shown to the left of the Settings drop-down menu, and allows the display to be renamed. This name is shown only in the web UI and browser and does not change any information shown in the UltraRes on-screen display. This can be useful to differentiate multiple Planar displays connected to the same LAN.

The bottom bar of the user interface contains pop-up menus for Views, Volume, Mute, Refresh, Power, Brightness, and Alerts.



Note: When a menu item is selected, the pop-up menu will remain visible until it is closed again. A red line above selected item indicates the pop-up menu is active.

- Views

- The Views button provides a pop-up menu that displays all the available multi-source layouts. Select a layout and drag it to the display canvas.

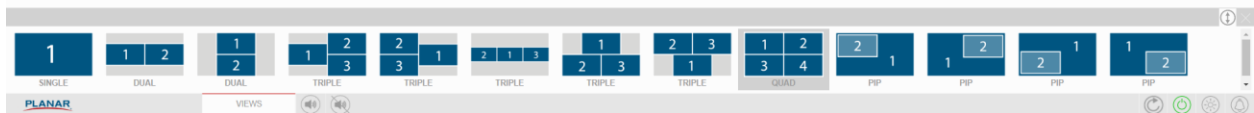
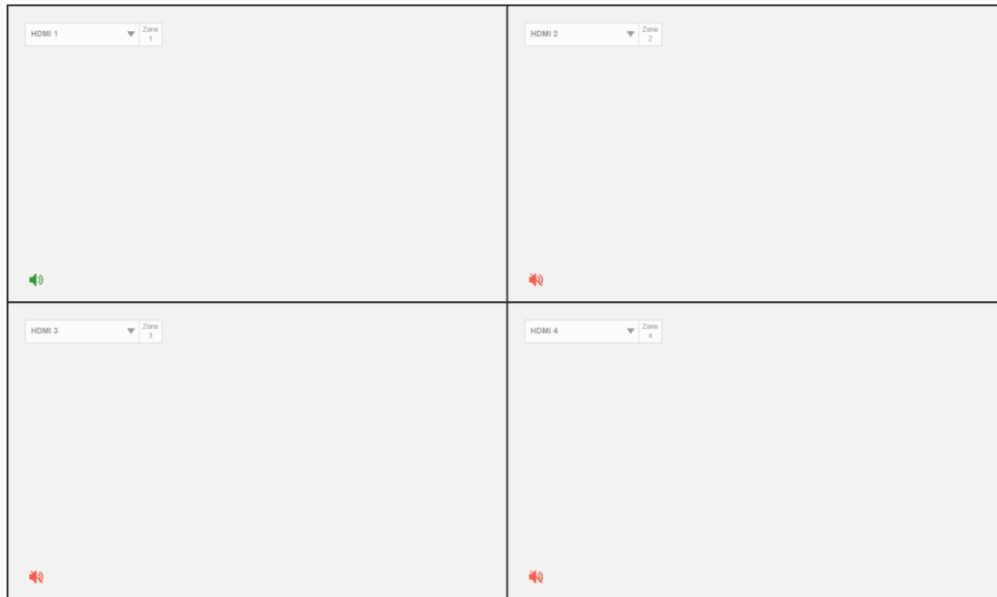

- Once a layout is placed in the canvas, each zone will contain a drop-down menu of available sources. Each zone will have an audio icon in the lower right representing which zone is currently playing audio. Refer to the “Inputs and Views Menu” on page 81 for more information.
- Audio
 - The audio icons provide volume adjustment, and system mute.

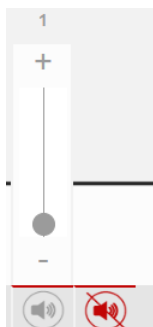

- The Refresh button forces the web interface to sync with the status of the display. This can be useful if changes have been made from an alternate control method.
- The Power button provides a pop-up menu with On and Off command. Refer to the “Power Submenu” on page 90 for more information.

- The Brightness button provides a pop-up menu with adjustment of the light intensity.

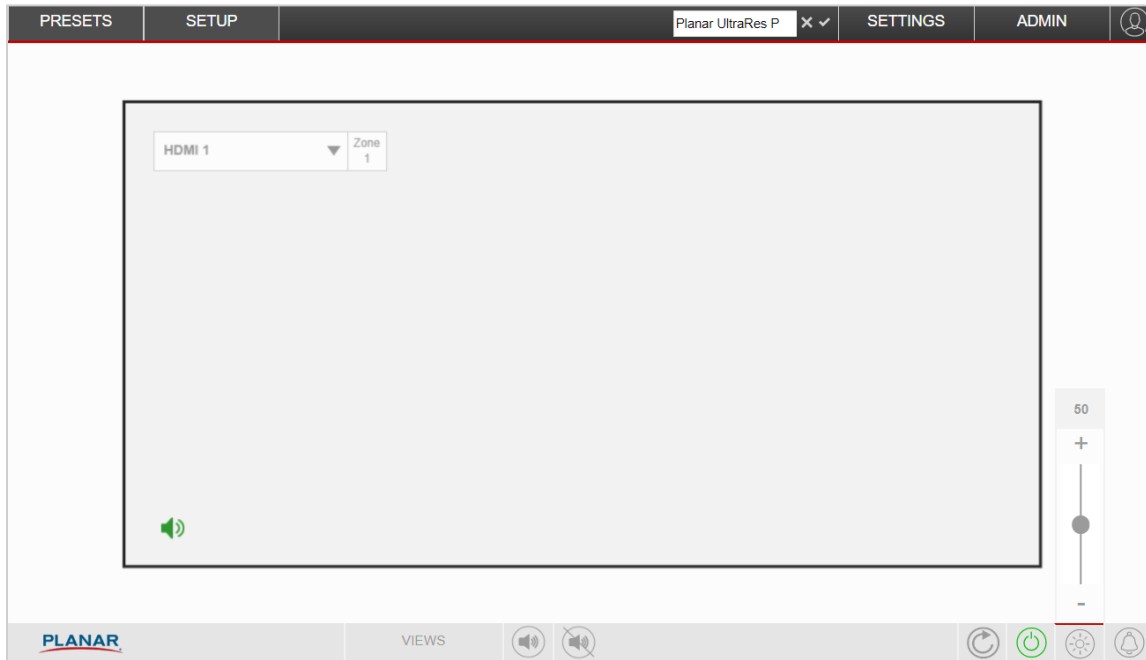

- The Alerts button provides a pop-up menu that displays information on any system alerts.

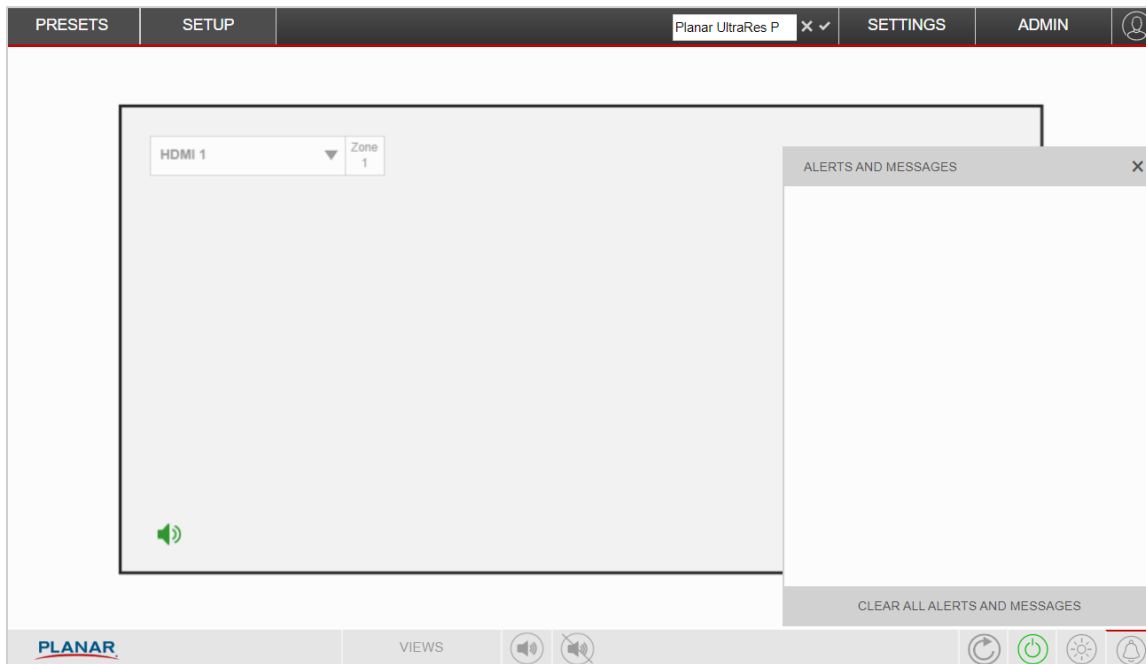

23. Admin

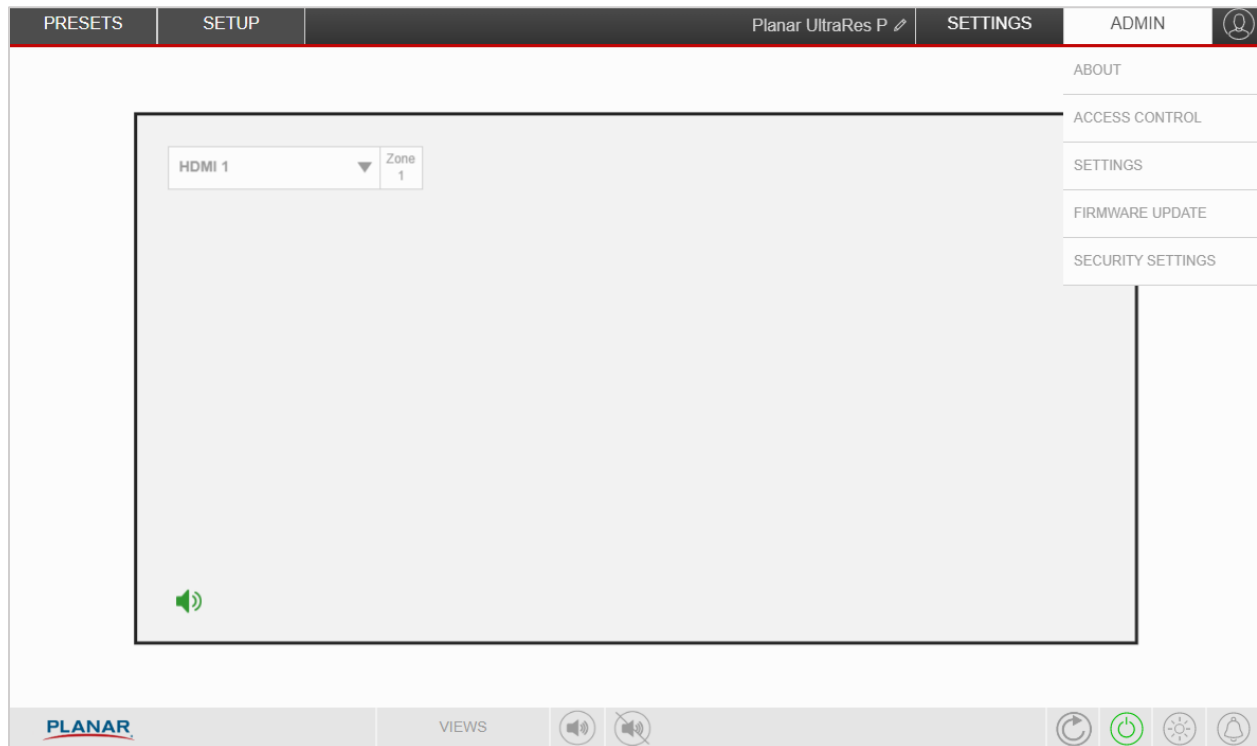

The Admin dropdown menu contains the following submenus:

- **About:** Provides the version number and licensing info for the UltraRes web interface

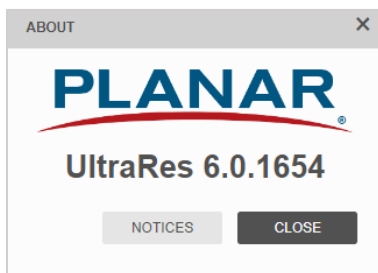

- **Access Control:** Manage Admin and User passwords

ACCESS CONTROL

Manage Passwords

Admin

Password

Confirm Password

Set Admin Password

User

Password

Confirm Password

Set User Password

Remove Passwords

Remove Passwords

CLOSE

- **Settings:** Generate or restore a settings package. This package will store all user settings. Refer to the “Save All Settings to USB” on page 109.

SETTINGS

Generate Settings Package

Download Settings Package

Save All Settings to USB

Restore Settings

Restore All Settings from USB

Click on "Generate Settings Package" to start collecting system settings

CLOSE

- **Firmware Update:** Update the Firmware from a Firmware file located on the connected computer. Refer to “Firmware Update” on page 109.

The screenshot shows a dialog box titled "FIRMWARE UPDATE" with a close button (X) in the top right corner. Inside the dialog, there are two buttons: "Select Firmware Package" and "Update Firmware". Below these buttons is a checkbox labeled "Start update when upload completes". Underneath the checkbox is a blue button that says "Select a firmware package file to upload". At the bottom right of the dialog is a "CLOSE" button.

- **Security Settings:** Configure the network security, keypad lock, IR Remote lock, and IR code. Refer to the “System Settings Submenu” on page 107.

The screenshot shows a dialog box titled "SECURITY SETTINGS" with a close button (X) in the top right corner. The dialog is divided into two sections. The first section is "Network" and contains three settings: "Enable SNMP" with an unchecked checkbox, "Enable TCP/UDP Commands" with a checked checkbox, and "TCP/UDP Commands Port (ports 80 & 443 are reserved)" with a text input field containing "465" and up/down arrow buttons. The second section is "Keypad and IR Remote" and contains three settings: "Keypad Lock" with an unchecked checkbox, "IR Remote Lock" with an unchecked checkbox, and "IR Remote ID Code" with a text input field containing "1785" and up/down arrow buttons. At the bottom right of the dialog is a "CLOSE" button.

24. Settings

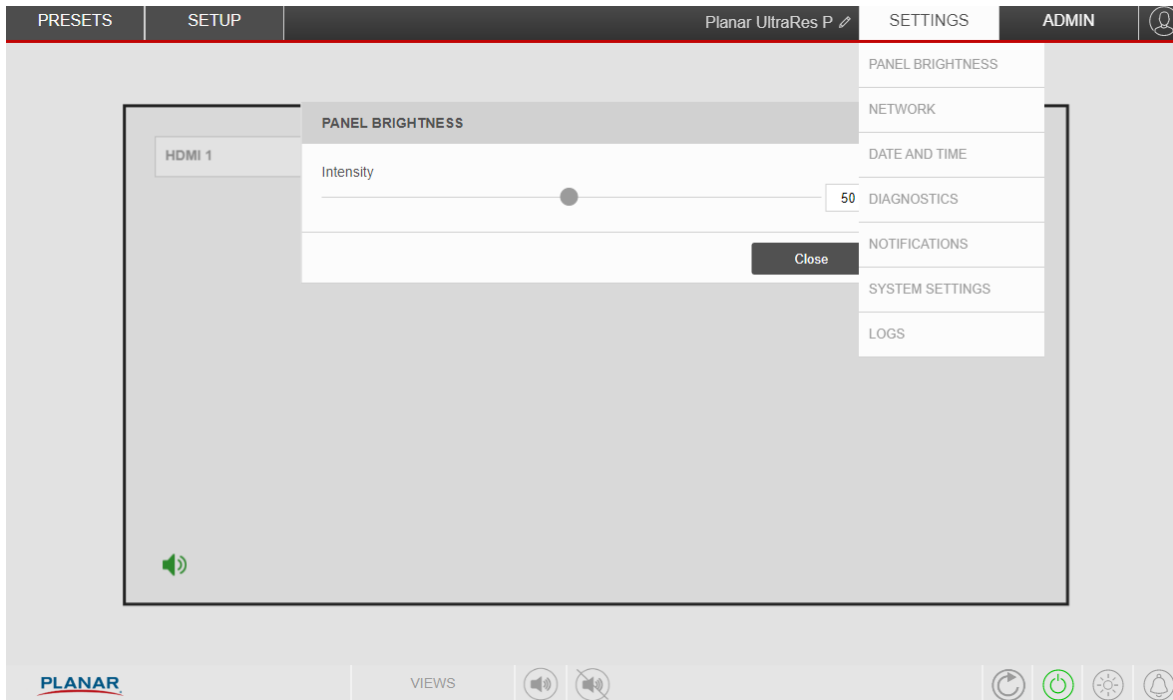

- **Panel Brightness:** Adjust the intensity of the display. Refer to the “Panel Brightness Submenu” on page 89.



- **Network:** Provides the network configuration. Refer to the “Network Submenu” on page 92.

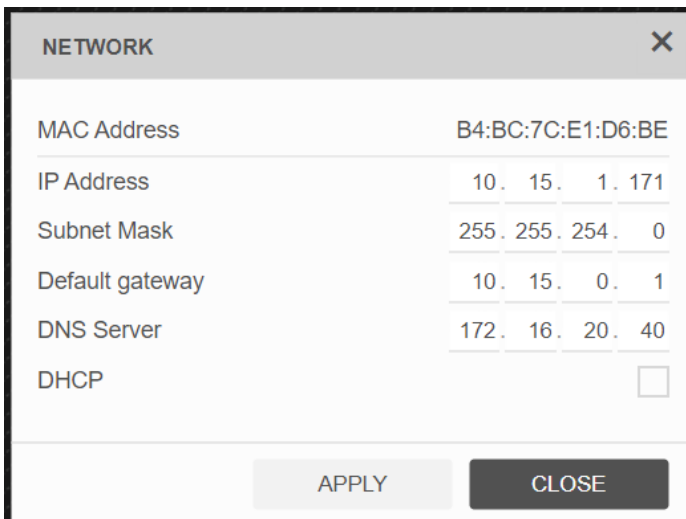

- **Date and Time:** Configure the date and time, and scheduled events. Refer to the “Schedule Submenu” on page 95.

DATE AND TIME
✕

Date and Time

Use Network Time

Time Zone (UTC-08:00) Pacific Time (US & Canada)

Date Apr 16, 2023 📅

Time 18:43 ✕

Scheduled Events

	Frequency	Day	Time	Action	Data	Enabled
1	Daily	Monday	00:00 ✕	Turn Off		<input type="checkbox"/>
2	Daily	Monday	00:00 ✕	Turn Off		<input type="checkbox"/>
3	Daily	Monday	00:00 ✕	Turn Off		<input type="checkbox"/>
4	Daily	Monday	00:00 ✕	Turn Off		<input type="checkbox"/>
5	Daily	Monday	00:00 ✕	Turn Off		<input type="checkbox"/>
6	Daily	Monday	00:00 ✕	Turn Off		<input type="checkbox"/>
7	Daily	Monday	00:00 ✕	Turn Off		<input type="checkbox"/>
8	Daily	Monday	00:00 ✕	Turn Off		<input type="checkbox"/>
9	Daily	Monday	00:00 ✕	Turn Off		<input type="checkbox"/>
10	Daily	Monday	00:00 ✕	Turn Off		<input type="checkbox"/>
11	Daily	Monday	00:00 ✕	Turn Off		<input type="checkbox"/>
12	Daily	Monday	00:00 ✕	Turn Off		<input type="checkbox"/>
13	Daily	Monday	00:00 ✕	Turn Off		<input type="checkbox"/>
14	Daily	Monday	00:00 ✕	Turn Off		<input type="checkbox"/>
15	Daily	Monday	00:00 ✕	Turn Off		<input type="checkbox"/>
16	Daily	Monday	00:00 ✕	Turn Off		<input type="checkbox"/>
17	Daily	Monday	00:00 ✕	Turn Off		<input type="checkbox"/>
18	Daily	Monday	00:00 ✕	Turn Off		<input type="checkbox"/>
19	Daily	Monday	00:00 ✕	Turn Off		<input type="checkbox"/>
20	Daily	Monday	00:00 ✕	Turn Off		<input type="checkbox"/>

CLOSE

- **Diagnostics:** Generate a diagnostics package. Refer to “Save Diagnostics to USB” on page 109.

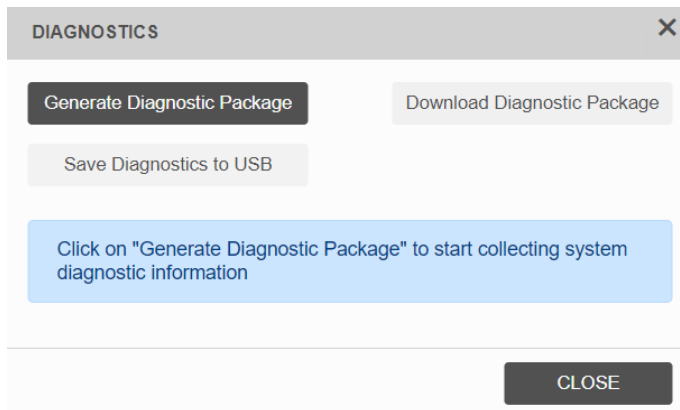

- Notifications
 - Email Account Settings
 - **SMTP Server:** The name of the outgoing SMTP server. Obtain this information from the network administrator.
 - **Connection Encryption:** Selects the appropriate encryption method required by the SMTP server.
 - **Port:** Selects the port that the SMTP server uses.
 - **Authentication:** Use Auto unless directed by the network administrator.
 - **User Name:** Login username for the SMTP server.
 - **Password:** Login password for the SMTP server.
 - **Email From Address:** The email address that will be shown in the “From:” field of the notification emails.
 - Events
 - **Power On/Off:** Occurs when standby mode is entered and when the display is powered on.
 - **System Error:** Occurs when the display has detected an error within the system.
 - **Source Detect:** Occurs when the display detects and displays a new input signal.
 - **Source Lost:** Occurs when the current input signal is no longer detected.
 - **Source Selected:** Occurs when a different input source is selected for any of the zones.
 - **Note:** Each event can be sent to one or more recipients. To add multiple email addresses, separate them by a space.

- **Test Email:** Sends a test of the selected email notification. This is useful for verifying that email account settings are setup correctly. If the test email fails, use the View Last 10 Log Messages button to get more detailed information about the failure.

NOTIFICATIONS SETTINGS ✕

Email Account Settings

SMTP Server

Connection Encryption TLS ▾

Port 465

Authentication AUTO ▾

User Name

Password

Email From Address

SMTP Server name is required

Events ▾

Event	Recipient(s)	Additional Note	Enabled
Power On/Off	<input style="width: 100%;" type="text"/>	<input style="width: 100%;" type="text"/>	<input type="checkbox"/>
System Error	<input style="width: 100%;" type="text"/>	<input style="width: 100%;" type="text"/>	<input type="checkbox"/>
Source Detect	<input style="width: 100%;" type="text"/>	<input style="width: 100%;" type="text"/>	<input type="checkbox"/>
Source Lost	<input style="width: 100%;" type="text"/>	<input style="width: 100%;" type="text"/>	<input type="checkbox"/>
Source Selected	<input style="width: 100%;" type="text"/>	<input style="width: 100%;" type="text"/>	<input type="checkbox"/>

Security Model User Based (USM)

Test Email ▾

Message Power On/Off ▾ TEST EMAIL

CLOSE

- System Settings

SYSTEM SETTINGS [X]

Settings [v]

Enable Status LED

Pixel Orbit

Enable CEC

Display Port Type 1.1 [v]

OSD Menus and Messages [v]

Menu Position CENTER [v]

OSD Transparency [Slider] 1

OSD Timeout OFF [v]

Allow Popup Messages

Allow Splash Screen

OSD Rotation LANDSCAPE [v]

Blank Screen Color CYAN [v]

CLOSE

- Logs

LOGS [X]

#	DATE	HOUR	LEVEL	MESSAGE
1				
2				
3				
4				
5				
6				
7				
8				
9				
10				
11				
12				
13				

CLOSE

25. Setup

The Setup tab provides dropdown menus that contains information about the display and provides a means of controlling the display. Refer to the relevant section of “Navigating Through the Menus” on page 80 for more information on each of these items.

- Display
 - **Summary:** Provides the status of the display's current video and audio layout, IP address, model name, serial number, and firmware version. Panel brightness, power settings, and test patterns, can be viewed and adjusted.

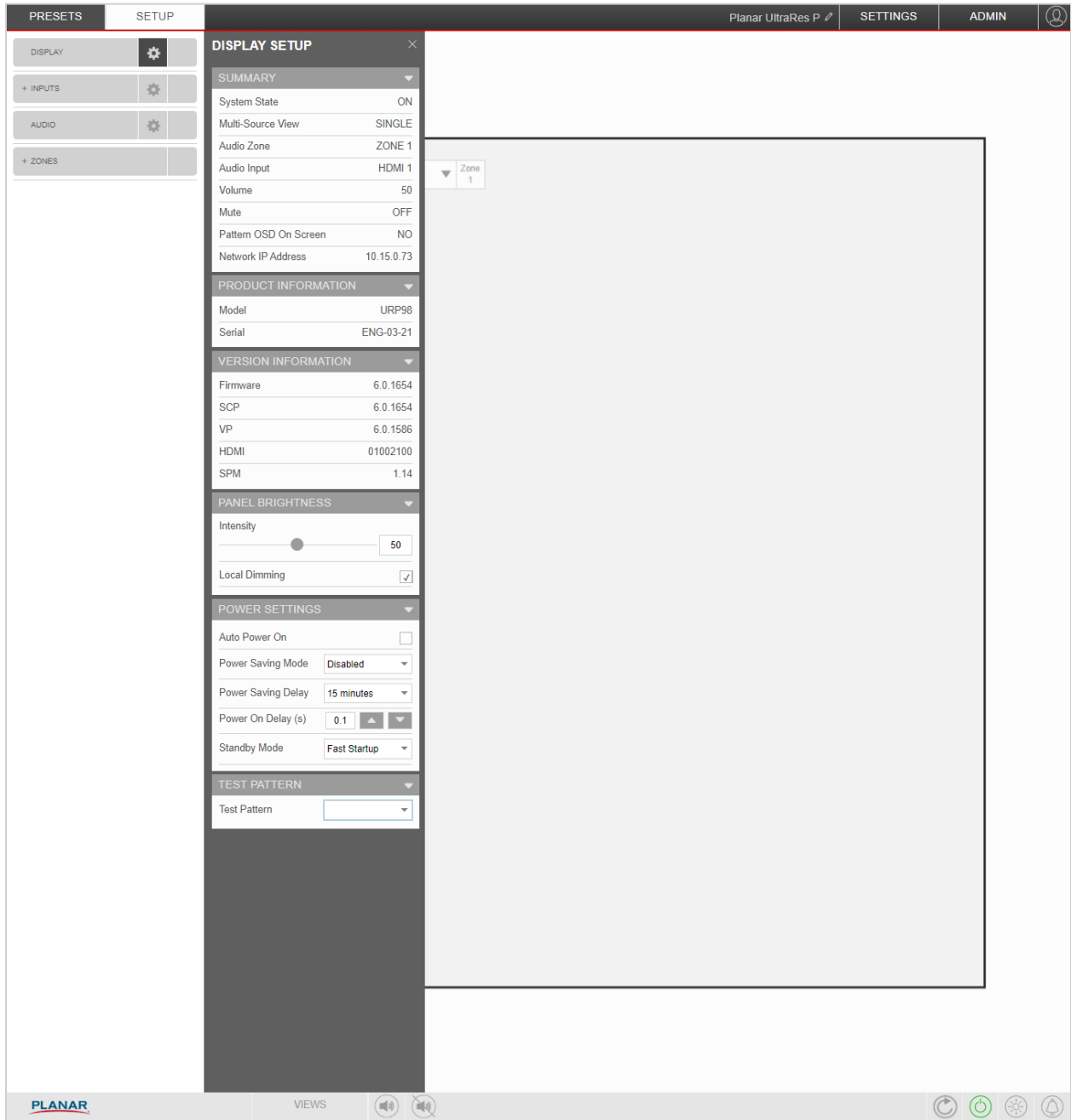

- Inputs
 - Adjust the Auto Scan Sources settings, and configure EDID for each input.

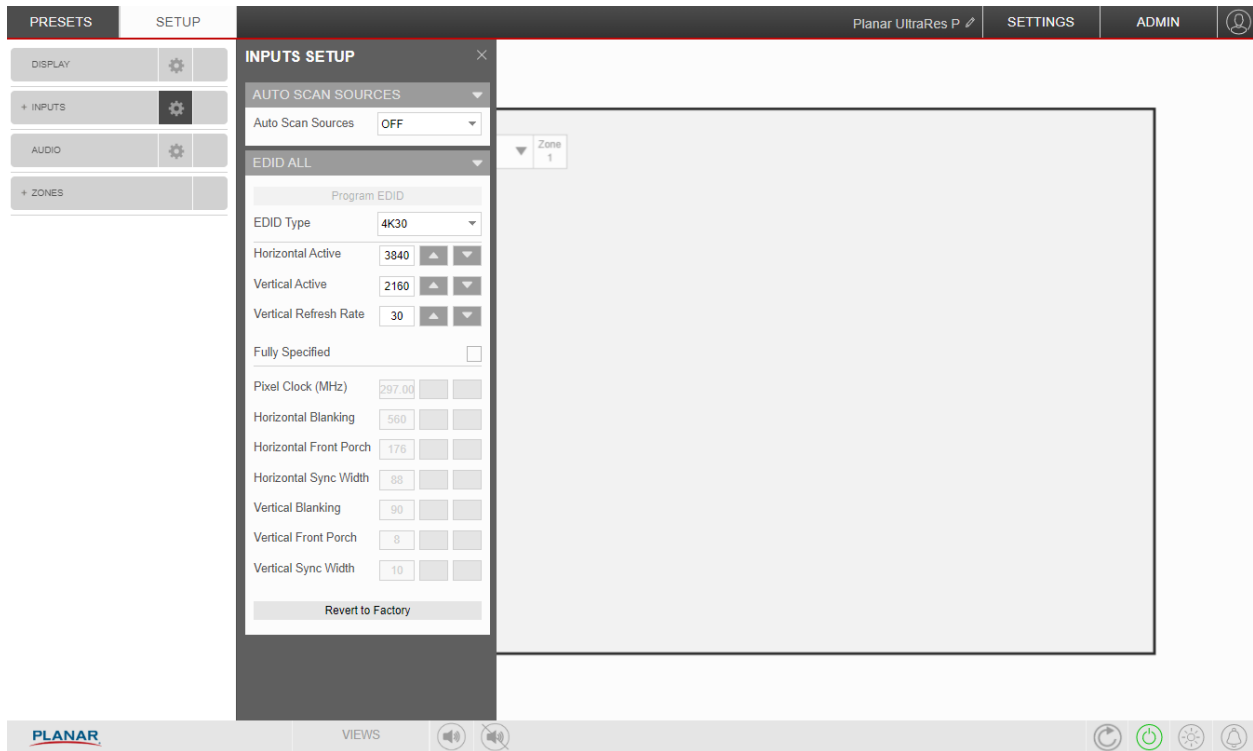

- Audio
 - Adjust the audio settings.

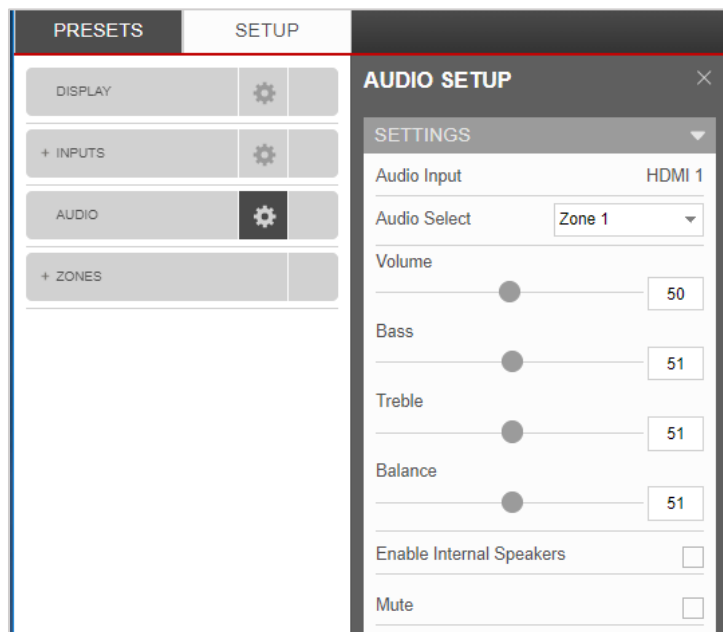

- Zones
 - Provides the image information and image adjustments for each source connected to the display
 - The “Eye” icon will show the current layout of zones on the canvas

- Presets
 - View, create, save, delete, and name presets. Refer to the “Presets Menu” on page 88.

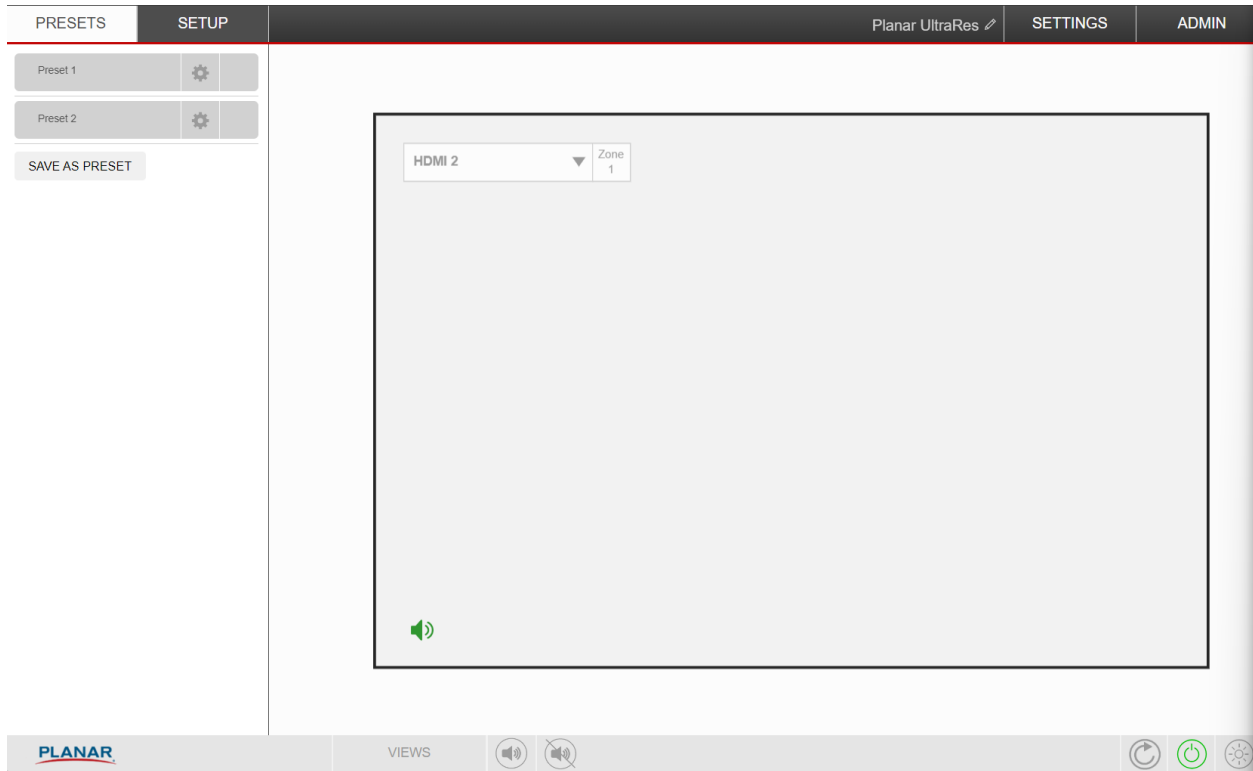

26. WallDirector Cloud

WallDirector Cloud is a secure cloud service offering for remotely monitoring and managing all supported Planar devices. Organizations can observe system health, investigate incidents, and troubleshoot issues within a centralized dashboard. Equipment data (device telemetries), incidents (device alerts), and spaces (device groupings) are presented in an intuitive view. In the event Planar Tech Support is needed, a ticket can be opened directly from WallDirector Cloud with all system information. WallDirector Cloud provides real-time information, enhances operational efficiency, and reduces the need for on-site visits.

26.1 Creating an Account

1. Create an account at <https://cloud.planar.com/> if it does not exist. (The first account created for the organization will be the administrator by default.)

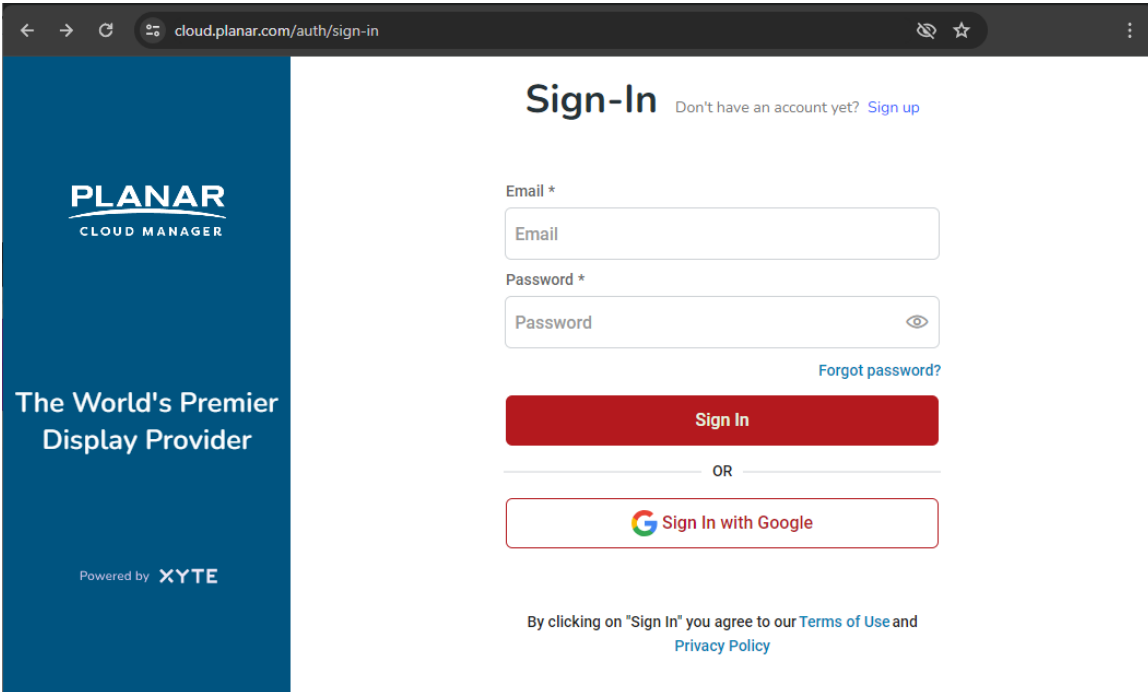

The screenshot shows a web browser window at the URL `cloud.planar.com/auth/sign-in`. The page features a dark blue sidebar on the left with the Planar logo and the text "The World's Premier Display Provider" and "Powered by XYTE". The main content area is white and titled "Sign-In". It includes a link for "Don't have an account yet? Sign up". There are two input fields: "Email *" and "Password *". Below the password field is a "Forgot password?" link. A red "Sign In" button is positioned below the input fields. Below the button is an "OR" separator and a "Sign In with Google" button. At the bottom, there is a disclaimer: "By clicking on 'Sign In' you agree to our Terms of Use and Privacy Policy".

2. Follow the prompts for username and password requirements to complete this account setup.

Note: The organization name will be the main title of the WallDirector Cloud web page.

3. As part of the sign-up, additional email invitations to individuals that will use the service may be added as necessary. This may also be done later in the administrator account web page.

Note: It is easier for an administrator to add and remove members to the group than having individuals create accounts and gain access. Use the link below on the website to configure users and permissions.

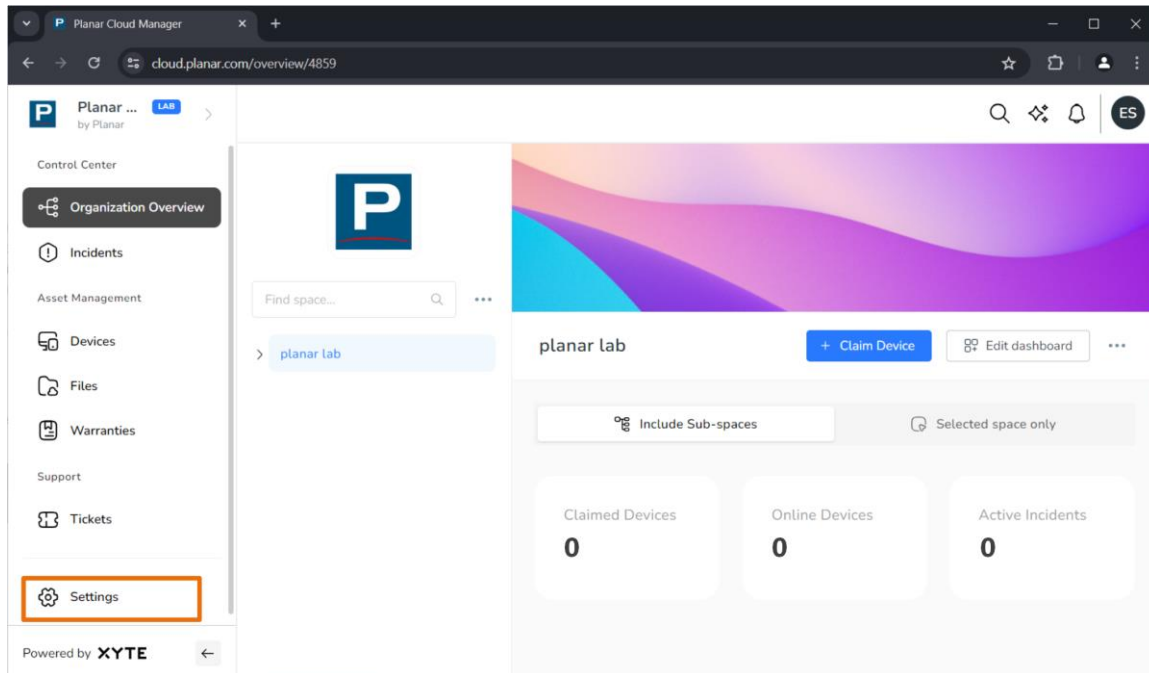

26.2 Equipment Management

To connect equipment to the WallDirector Cloud, the equipment must be connected to a WAN and have access to the Internet.

Note: All network communications between Planar products and WallDirector Cloud are HTTPS requests initiated from the Planar product to servers in the xyte.io or planar.com domains. DNS is required to be available and configured for the Planar product to resolve servers by FQDN.

1. Configure the Network Settings in the device to have an IP address and other necessary parameters to allow access to outside commands and queries. See Network Settings on page 123.

Note: Verification that the network connection is correctly set up prior to the next step is highly recommended.

- a. To verify use the serial command: `NETWORK.PING="status.xyte.io"`
- b. If the returned result is one of these indicators (0, DISABLE, OFF, NO, FALSE), then there are problems with the connection setup. Verify the equipment is on an active network and review the Internet connection parameters from step 1.

2. Browse to Cloud Manager within the equipment's web page.

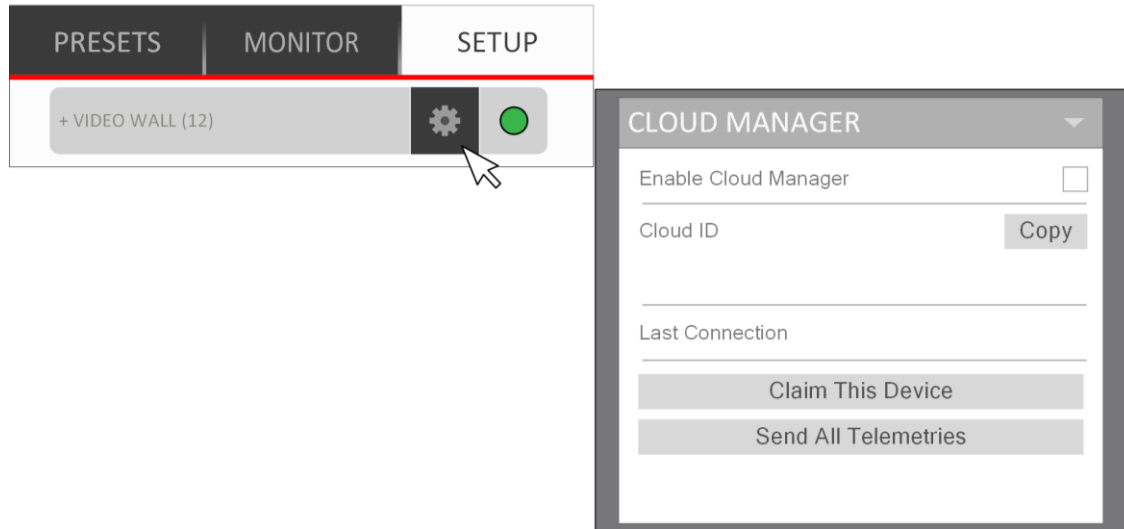

3. Check **Enable Cloud Manager**. This will create a network link between the WallDirector Cloud and the equipment.

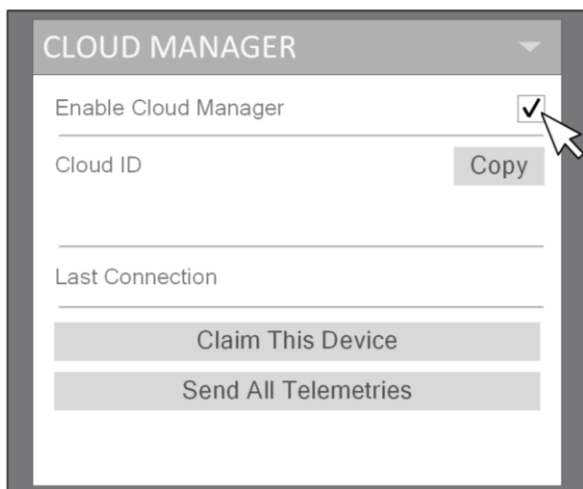

4. Once the Last Connection has updated its time stamp to the current time, click **Claim This Device**. This will register this device to the account set up on the computer being used on the PC.

If the PC is not logged into the account, a prompt to login will appear. Log in and continue.

5. A popup will appear in the top right corner of the browser indicating a successful claim of this device. The device will appear up under the organization in the **Unsorted** category.

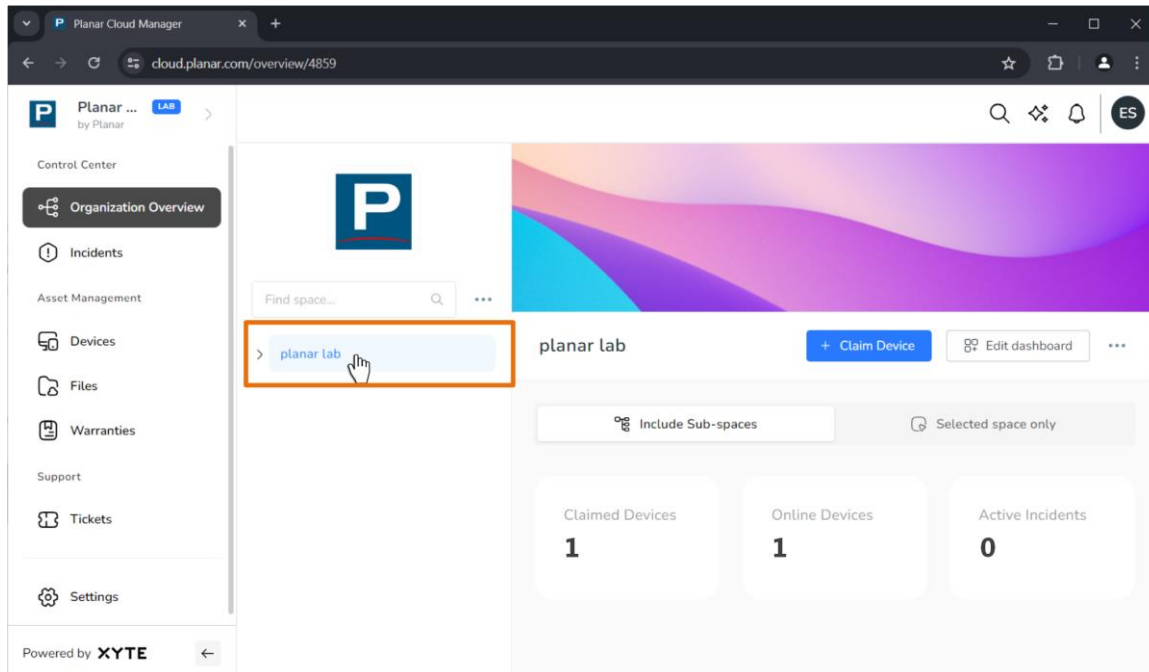

6. Refer to <https://docs.xyte.io/> for details on how to configure and operate WallDirector Cloud effectively.

External Control

In addition to using the Planar UltraRes L Series remote control and display, there are other methods of controlling the Planar UltraRes L Series display externally:

- Using a serial link to send ASCII commands and to receive responses to those commands. The same set of commands can be sent over RS-232, USB, TCP or UDP. See the Planar UltraRes L Series RS232 User Manual for more information.
- Using discrete infrared (IR) codes to program a third-party remote control. See "IR Command Protocol" on page 75.
- Using the Planar UltraRes Web UI to access the settings in the OSD as well as some additional features via a web browser. See "Planar UltraRes Web UI" on page 114.
- Using HDMI-CEC with compatible devices. See "CEC" on page 108.

Signal Compatibility

Signal Type	Resolution	Frame rate (Hz)	Line Rate (kHz)	Pixel Rate (MHz)	HDMI 1-2	HDMI 3-4	DisplayPort	References
PC	640x480	59.94	31.469	25.175	x	x	x	VESA DMT, CEA-861-F Format 1
	640x480	72	37.861	31.500	x	x	x	VESA DMT
	640x480	74.99	37.500	31.500	x	x	x	VESA DMT
	640x480	85	43.269	36.000	x	x	x	VESA DMT
	800x600	60.32	37.890	40.000	x	x	x	VESA DMT
	800x600	72	48.077	50.000	x	x	x	VESA DMT
	800x600	75	46.875	49.500	x	x	x	VESA DMT
	800x600	85.06	53.674	56.250	x	x	x	VESA DMT
	848x480	59.659	29.830	31.500	x	x	x	VESA CVT
	848x480	74.769	37.684	41.000	x	x	x	VESA CVT
	848x480	84.751	42.969	46.750	x	x	x	VESA CVT
	1024x768	60	48.363	65.000	x	x	x	VESA DMT
	1024x768	70	56.476	75.000	x	x	x	VESA DMT
	1024x768	75.03	60.023	78.750	x	x	x	VESA DMT
	1024x768	85.03	68.677	94.500	x	x	x	VESA DMT
	1152x864	70.012	63.851	94.500	x	x	x	VESA DMT
	1152x864	75	67.500	108.000	x	x	x	VESA DMT
	1152x864	84.999	77.094	121.500	x	x	x	VESA DMT
	1280x768	49.929	39.593	65.250	x	x	x	VESA CVT
	1280x768	59.995	47.396	68.250	x	x	x	VESA CVT-R
1280x768	60	47.776	79.500	x	x	x	VESA CVT	
1280x768	74.893	60.289	102.250	x	x	x	VESA CVT	

Signal Type	Resolution	Frame rate (Hz)	Line Rate (kHz)	Pixel Rate (MHz)	HDMI 1-2	HDMI 3-4	DisplayPort	References
PC	1280x768	84.837	68.633	117.500	x	x	x	VESA CVT
	1280x960	60	60.000	108.000	x	x	x	VESA DMT
	1280x960	75	75.000	126.000	x	x	x	VESA DMT
	1280x960	85.002	85.938	148.500	x	x	x	VESA DMT
	1280x1024	60.02	63.981	108.000	x	x	x	VESA DMT
	1280x1024	75.02	79.976	135.000	x	x	x	VESA DMT
	1280x1024	85.02	91.146	157.500	x	x	x	VESA DMT
	1360x768	60	47.712	85.500	x	x	x	VESA DMT
	1400x1050	49.965	54.113	100.000	x	x	x	VESA CVT
	1400x1050	60	64.7	101.00	x	x	x	VESA CVT-R
	1400x1050	60	65.317	121.750	x	x	x	VESA CVT
	1400x1050	74.867	82.278	156.000	x	x	x	VESA CVT
	1600x1200	60	75.000	162.000	x	x	x	VESA DMT
	1920x1080	49.929	55.621	141.500	x	x	x	VESA CVT
	1920x1080	59.963	67.158	173.000	x	x	x	VESA CVT
	1920x1080	59.950	66.587	138.500	x	x	x	VESA CVT-R
	1920x1200	49.932	61.816	158.250	x	x	x	VESA CVT
	1920x1200	59.950	74.038	154.000	x	x	x	VESA CVT-R
	1680x1050	49.974	54.121	119.500	x	x	x	VESA CVT
	1680x1050	59.954	65.290	146.250	x	x	x	VESA CVT
	1920x2160	60	135.000	297.000	x	x	x	CEA-861-F, VIC 16, with vertical parameters doubled
	2560x1440	59.951	88.787	241.500	x	x	x	VESA CVT-R
	2560x1600	59.972	98.713	268.500	x	x	x	VESA CVT-R
3840x2160	24	52.438	209.750	x	x	x	VESA CVT-R	

Signal Type	Resolution	Frame rate (Hz)	Line Rate (kHz)	Pixel Rate (MHz)	HDMI 1-2	HDMI 3-4	DisplayPort	References
PC	3840x2160	30	65.688	262.750	x	x	x	VESA CVT-R
	3840x2160	50	110.500	442.000	x		x	VESA CVT-R
	3840x2160	60	133.313	533.250	x		x	VESA CVT-R
Apple Mac	640x480	66.59			x	x	x	
	832x624	75.087	49.107	55.000	x	x	x	
	1024x768	59.278	48.193	64.000	x	x	x	
	1024x768	74.927	60.241	80.000	x	x	x	
	1152x870	75.062	68.681	100.000	x	x	x	
SDTV	480i	60			x	x	x	SMPTE 125M, CEA-861-F Formats 6 & 7
	576i	50			x	x	x	ITU-R BT.601, CEA-861-F Formats 21 & 22
EDTV	480p	60	31.469	27.000	x	x	x	ITU-R BT.1358, CEA-861-F Format 17 & 18
	576p	50	31.250	27.000	x	x	x	SMPTE 125M, CEA-861-F Format 6 & 7
HDTV	1080i	50	28.125	74.500	x	x	x	SMPTE 274M, CEA-861-F Format 20
	1080i	60	33.750	74.250	x	x	x	SMPTE 274M, CEA-861-F Format 5
	720p	50	37.500	74.250	x	x	x	SMPTE 296M, CEA-861-F Format 19
	720p	60	45.000	74.250	x	x	x	SMPTE 296M, CEA-861-F Format 4
	1080p	24	27.000	74.250	x	x	x	SMPTE 274M, CEA-861-F Format 32
	1080p	25	28.125	74.250	x	x	x	SMPTE 274M, CEA-861-F Format 33
	1080p	30	33.750	74.250	x	x	x	SMPTE 274M, CEA-861-F Format 34
	1080p	50	56.250	148.500	x	x	x	SMPTE 274M, CEA-861-F Format 31
	1080p	60	67.500	148.500	x	x	x	SMPTE 274M, CEA-861-F Format 16

Signal Type	Resolution	Frame rate (Hz)	Line Rate (kHz)	Pixel Rate (MHz)	HDMI 1-2	HDMI 3-4	DisplayPort	References
UHDTV	3840x2160	24	54.000	297.000	x	x	x	CEA-861-F Format 93, HDMI 1.4b VIC 1
	3840x2160	25	56.250	297.000	x	x	x	CEA-861-F Format 94, HDMI 1.4b VIC 2
	3840x2160	30	67.500	297.000	x	x	x	CEA-861-F Format 95, HDMI 1.4b VIC 3
	3840x2160	50	67.500	297.000	x			CEA-861-F Format 96, 4:2:0 sub-sampling
	3840x2160	50	135.000	594.000	x		x	CEA-861-F Format 96
	3840x2160	60	67.500	297.000	x			CEA-861-F Format 97, 4:2:0 sub-sampling
	3840x2160	60	135.000	594.000	x		x	CEA-861-F Format 97

Color Subsampling Report

Video Timing	Input	RGB 4:4:4 Supported	YUV 4:4:4 Supported	YUV 4:2:2 Supported	YUV 4:2:0 Supported
4K @ 50/60 Hz	DP	x	x	x	
4K @ 50/60 Hz	HDMI 1-2	x	x	x	x
4K @ 50/60 Hz	HDMI 3-4				
All Other Supported Timings	Any	x	x	x	

Power Consumption

The power consumption values stated in the Specifications table are based on a fully lit display showing a white screen except where noted. Maximum consumption data is based on all inputs being utilized. Typical values are based on a single input consisting of a white image displayed across the entire screen with a brightness setting of 75 (as shipped). Actual use will vary and it is always best practice to plan for the worst case scenario.

Specifications

Item	Model: URL122-MFT
Display Diagonal	122in
Display Active Area	106.3" x 59.8" (2700mm x 1518.75mm)
Display Resolution	Full HD (1920 x 1080)
Aspect Ratio	16:9
Pixel Pitch	1.40625 mm
Pixel Density	505,679/m ² 46,979/ft ²
Contrast Ratio	5000:1
Brightness	800 nits (max)
Response Time (typ)	<1 ms
Frame Rate	60Hz
Color Gamut	90% of P3
HDR (High Dynamic Range)	HDR10
Color Temperature, Adjustable (k)	3,000 - 12,000; 6500, 9300, 12000 presets
Viewing Angle (typ)	160°
External Connections	DisplayPort 1.2 in x 1, DisplayPort out, HDMI 2.0 x 2 (HDCP 2.2), HDMI 1.4 x 2, USB-B (for touch controller)
Display Control	IR, RS-232, LAN, HDMI-CEC, Keypad, Web Browser Interface
Multi-Source Views	PiP, Dual, Triple, Quad
Modes	4x 1920x1080 @ 24/25/30/50/60Hz; 480p, 576p, 720p @ 50/60 Hz; 1080p @ 24/25/30/50/60Hz; 1080i @ 50/60 Hz
Audio Input	PC Line In
Audio Output	PC Line Out, S/PDIF
Speakers	10W x 2 built-in
Mounting	Wall mount included. External device mounting: 75mm x 75mm. Optional rolling floor stand available.
Fanless	Yes
AC Inlet	IEC C20
Power Consumption (full white / black screen)	1460W / 365W

Item	Model: URL122-MFT
Power Consumption (Typ.)	1050W
Standby	<0.5W
BTU/hr (Typ.)	3582 BTU/hr
Line Voltage	100-240V; 50/60Hz
Service Access	Front, Rear
Environment	Indoor
LED Type	Direct View micro-LED 6in1 Flip Chip
LED Refresh Rate	>3840
LED Lifetime (to half brightness)	100,000 hrs (min)
Display Dimensions	107.6" x 64.0" x 3.24" (2732.0mm x 1624.8mm x 82.4mm)
Bezel Width	0.63" (16.0mm) Left, Right and Top 3.54" (90.0mm) Bottom
Installed Depth (from Wall)	3.4" (86.4mm)
Dimensions including Wall Mount	107.6" x 64.0" x 3.41" (2732.0mm x 1624.8mm x 86.6mm)
Dimensions including Optional Stand	107.6" x 88.0" x 35.5" (2732.0mm x 2234.7mm x 901mm) or 107.6" x 92.0" x 35.5" (2732.0mm x 2334.7mm x 901mm) max
Display Weight	111.4kg 245.0lbs
Display Weight with Wall Mount	122.3kg 269.0lbs
Display Weight with Optional Stand	175.5kg 386.0lbs
Operating Temperature	0° to 40° C 32° to 104° F
Operating Humidity	10-80%
Storage Temperature	-20° to 65° C -4° to 150° F
Storage Humidity	10-85%
Touch Technology	IR touch: 10 points
OS Compatibility	Windows 10, 11, Mac OSX and Linux
Features	MediaPlex Plus Processing, Scheduling, Presets
Solution Includes	URL122 display, US and EU power cords, HDMI cable, USB A to B cable, IR cable, remote control, vacuum removal tool and charger, gloves, and Quick Start Guide
Approvals	FCC Class A, cTUVus, CE, RoHS

Item	Model: URL122-MFT
Recommended Usage	Up to 24x7 operation
Warranty	5 years
Security	No WiFi, no Android O/S, signed and encrypted firmware

Dimensions

27. URL122 Display

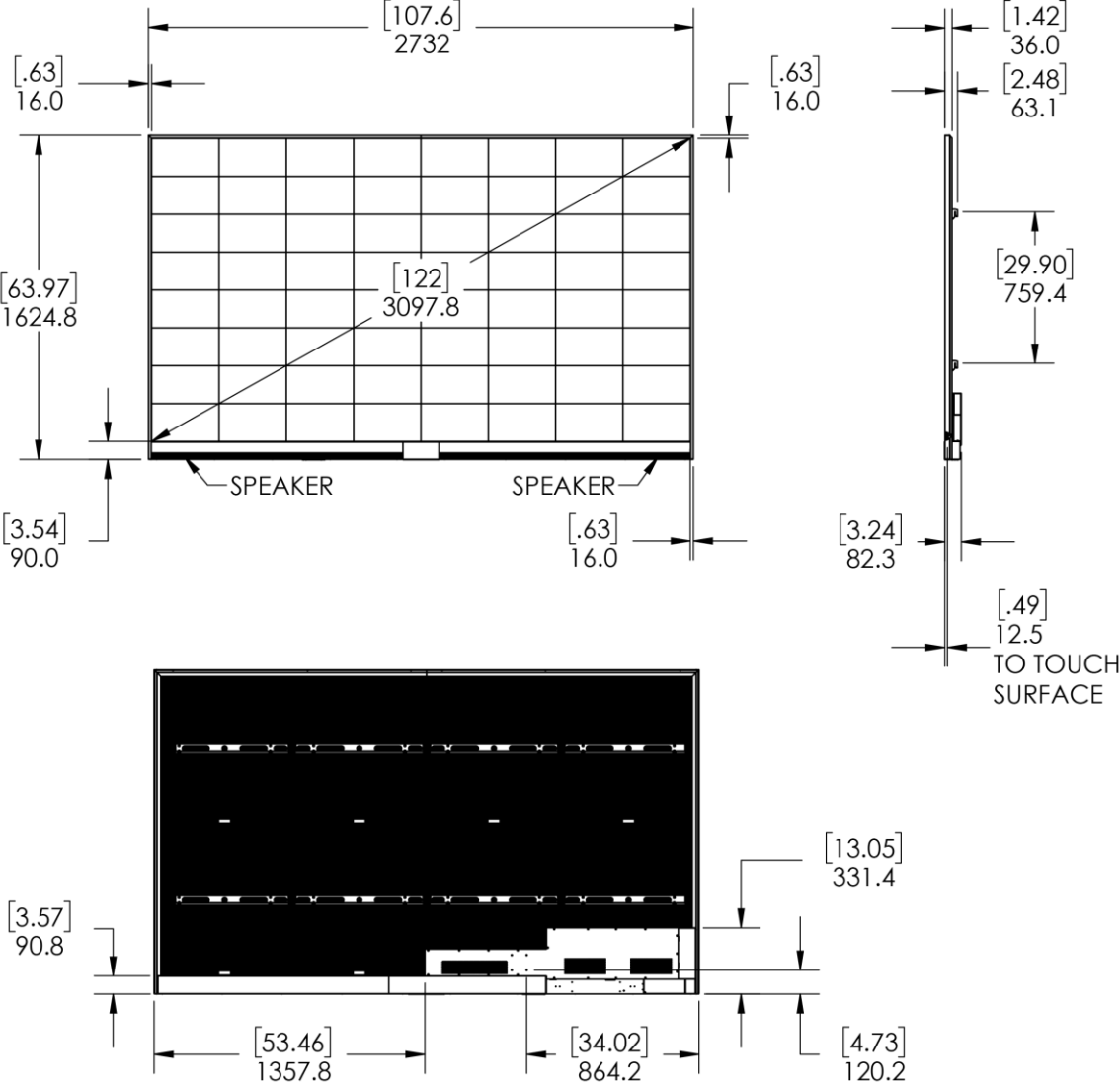

28. Display and Included Wall Mount

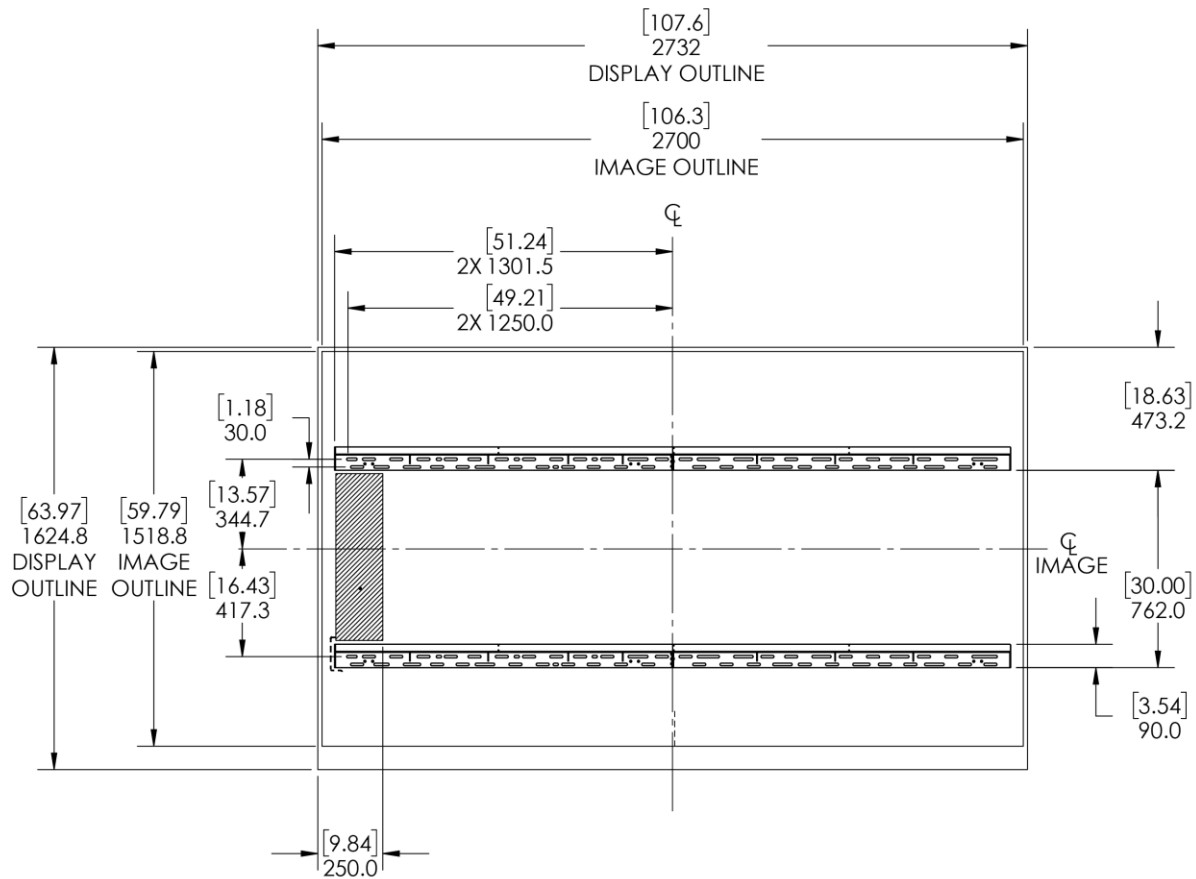

MINIMUM GAP TO CEILING		
	'A'	
CONDITION	mm	in
RECOMMENDED	102	4.0
TOOL ACCESS	75	3.0
TRIM INSTALL	60	2.4
COLUMN INSTALL	30	1.2

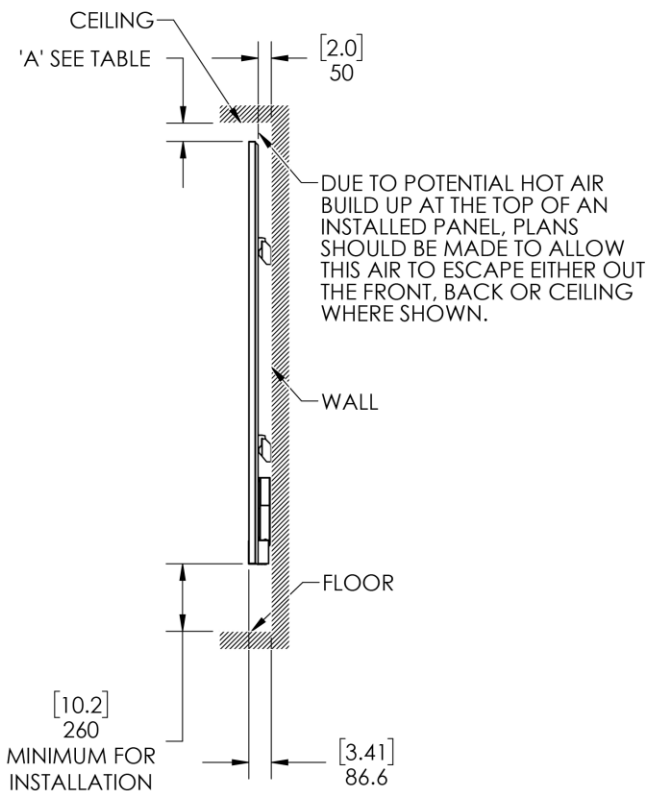

29. Display and Optional Rolling Cart

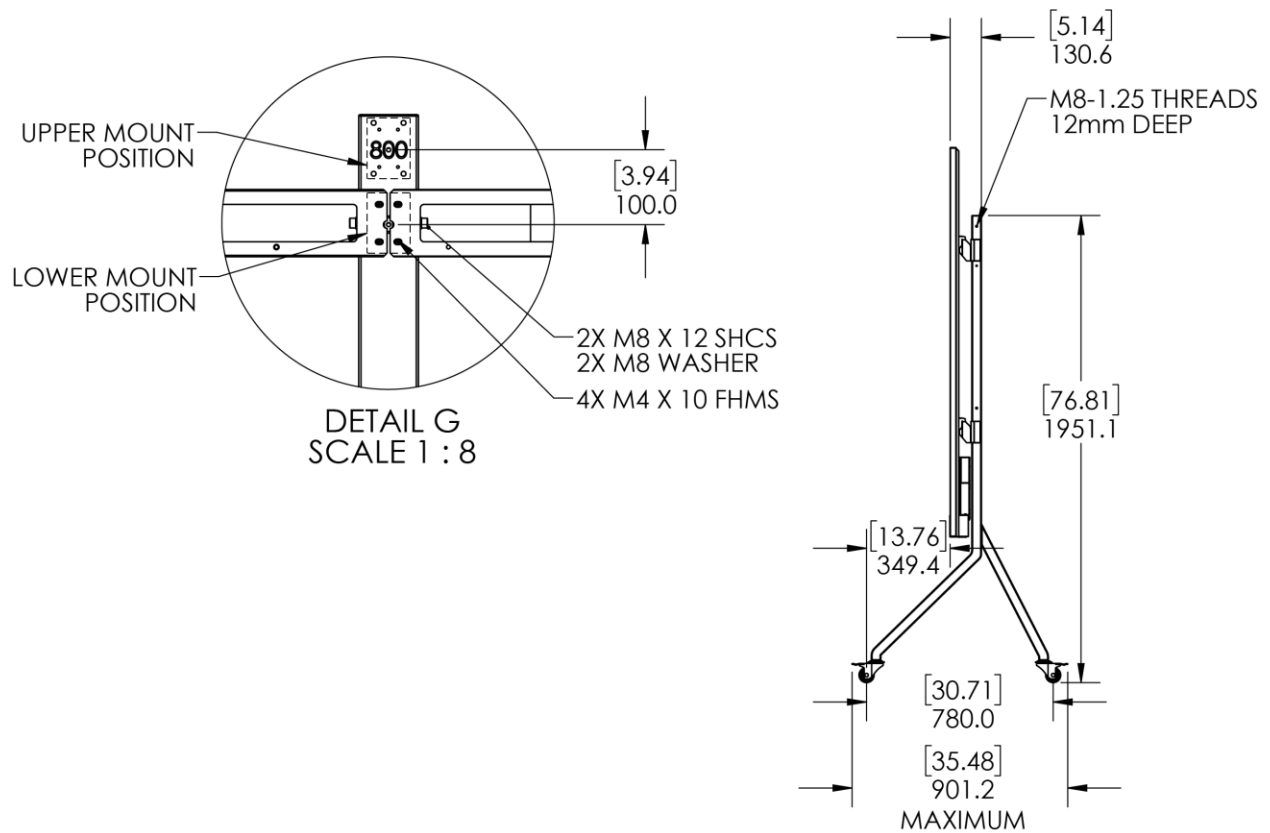
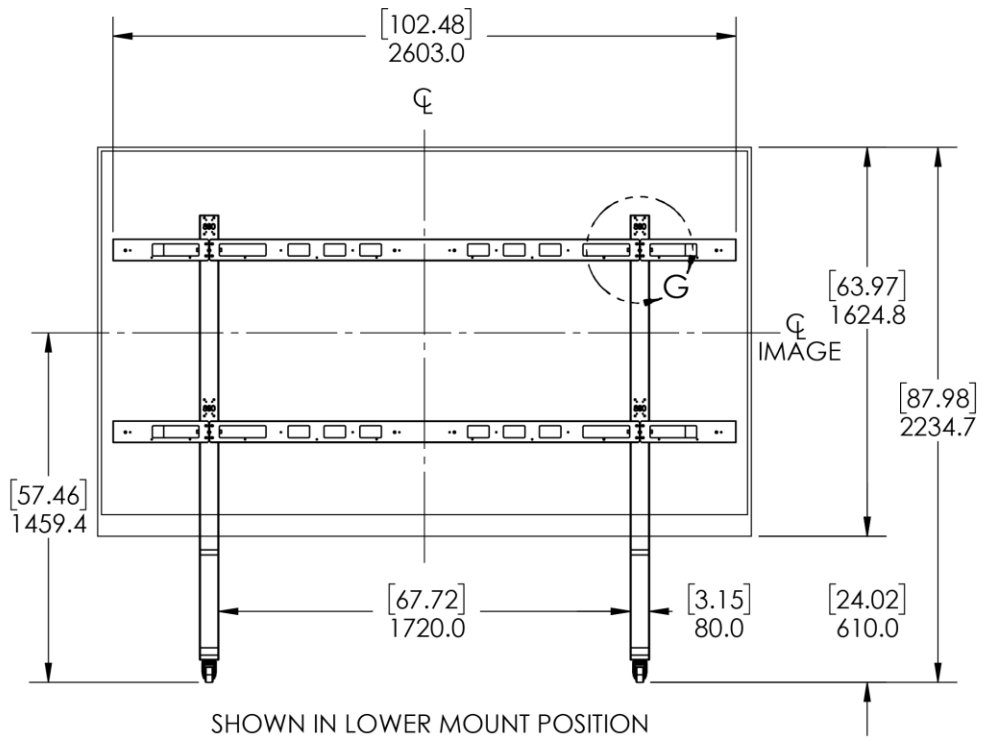

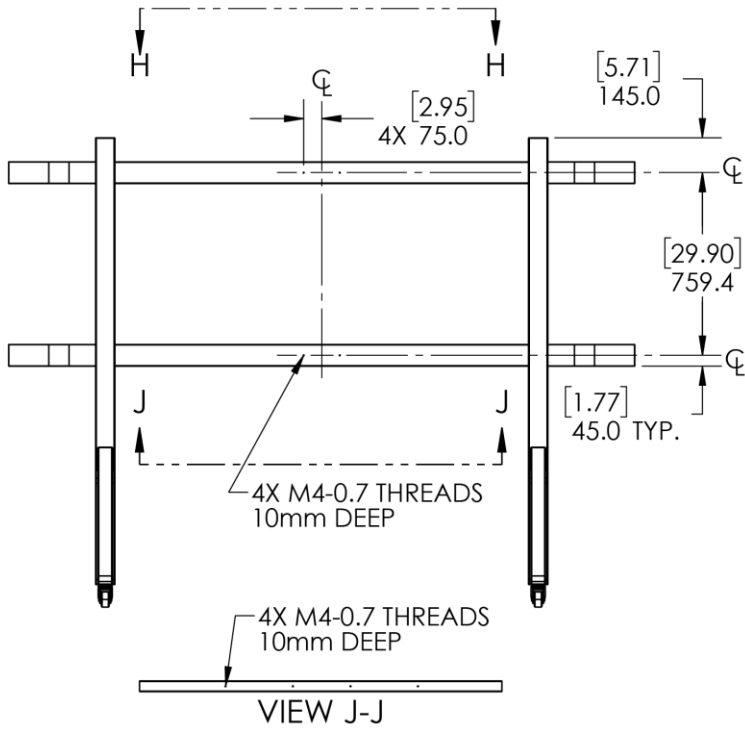
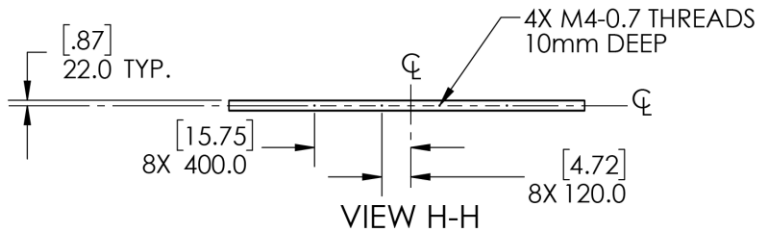

Troubleshooting During Installation

This section includes troubleshooting information about issues encountered during the installation process or after the display has been running for some time. If the solutions in this section are unable to remedy the issues, please contact Planar's Technical Support team for assistance.

30. Error Codes

To see the last 50 errors that have occurred, select the Error Log tab in the OSD (MAIN MENU > INFORMATION > ERROR LOG), as shown below.

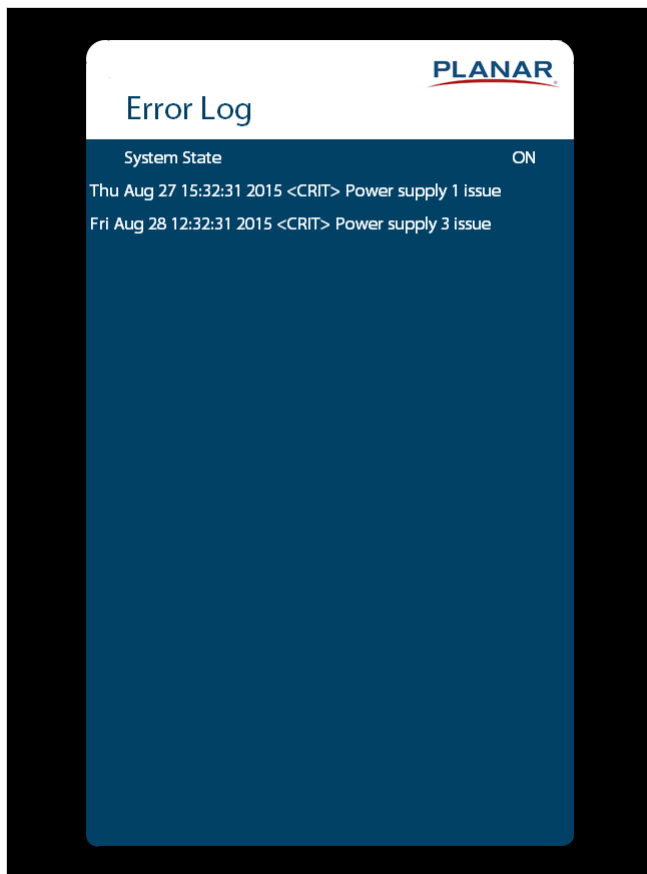

31. Symptoms, Possible Causes and Solutions

Below are different symptoms that might be encountered as the Planar UltraRes L Series display is installed. First look at the different symptom descriptions for the issue. Then look at the possible cause and try the suggested solution(s). If the solution does not resolve the issue, please contact Planar's Technical Support Department.

31.1 Symptom: Display Doesn't Respond to External Control System

Solution

Confirm the **Power Down Mode** setting. **Networked standby** or **Fast Startup** are required to enable the use of external control devices. **Standby** disables all external control except IR, allowing the display to be in the lowest power setting. See "Power Down Mode" on page 91.

31.2 Symptom: Can't Get PC to Output 4K @ 24/30/60 Hz

Solution

Confirm that DisplayPort-to-HDMI adapters are not being used. These adapters do not support outputting 4K content.

Solution

Ensure a high-speed HDMI or a Certified Premium HDMI cable is being used. Standard HDMI cables might work but are not guaranteed.

Solution

Verify that the selected **EDID Type** setting in the OSD is **4K60** or **4K30**. If the EDID setting is changed, the cable may need to be disconnected and reconnected.

Solution

When using 4K @ 60 Hz on HDMI, the display must be connected to HDMI 1 or HDMI 2.

Solution

When using 4K @ 60 Hz on HDMI 1 or HDMI 2, the Multi-Source View setting must be Single.

31.3 Symptom: Can't Get PC to Output 4K @ 24/30/60 Hz

Possible Cause

The connector overmold is too large, which can cause the pins not to contact properly on some cards.

Solution

If using DisplayPort, make sure the connector overmold isn't too large.



31.4 Symptom: HDCP 2.2 Sources Are Not Visible

Solution

If HDMI 1 and HDMI 2 are both being shown on the display at the same time, only HDMI 1 will support HDCP 2.2 content. Change the source output to a reduced version of HDCP. If the source does not allow a reduced output, a third party HDCP converter may be required.

Solution

HDMI 3 and 4 do not support HDCP 2.2 sources. Connect source to HDMI 1 or 2.

Solution

Multi source view mode supports a maximum input resolution of 3840X2160@30Hz. 4K@60 sources are compatible only in single source view mode. Configure the EDID in the UltraRes settings menu for each input to 4K@30.

31.5 Symptom: IR Isn't Working Properly

Possible Cause

The wired IR module may not be fully connected.

Solution

Make sure the IR is fully connected by pressing hard to ensure it is inserted as far as possible.

Possible Cause

The wired IR module cable is not being used.

Solution

Make sure that the wired IR module cable is being used.



31.6 Column(s) Not Displaying an Image

Possible Cause

The power cable from the power supply to the electronics is not installed correctly.

Solution

If no lights are present on the electronics, remove AC power from the system and reinstall the column power cable to the electronics.

Possible Cause

The signal cable(s) directly connected to the column input or from the previous columns output is not installed correctly.

Solution

Remove AC power from the system and reinstall the flex cable between columns or the main input flex cable.

Possible Cause

The power connection between left and right electronics boxes is not connected.

Solution

If no lights are present on the right two columns electronics, remove AC power from the system and reinstall the power cable between the right and left electronics box.

31.7 Display Has Dark Lines in Bright Image or Is Not Smooth to the Touch

Possible Cause

Modules are out of alignment.

Solution

Review section 13 (see page 65) in this manual.

Possible cause

Gaps between modules.

Solution

Swap modules where the gap is occurring.

Possible cause

Columns are not aligned correctly.

Solution

Screws can be added/tightened between columns as noted in section 10.6 step 12 (see page 39). Remove the top middle and bottom modules of the right affected column to access screw points.

31.8 Touch Is Not Working

Possible Cause

Cable from PC to Display is not fully inserted.

Solution

Verify both ends of the USB A to USB B cable are connected.

Possible Cause

Source is not HID Compliant, or the program being run on the source does not support touch.

Solution

Verify with the manufacturer of the source of program that touch is supported

Note: Refer to the section of the manual for assembling the electronics cover and trim, to access the connection points.

Solution

Open Windows Device Manager, and click the "Human Interface Devices" drop-down menu. Confirm there is an entry for "HID-compliant touch screen". If one is not present, the internal connections for the touch sensor may not be properly connected.

Possible Cause

- The USB cable connection between the electronics cover and the electronics was not fully connected.
- The ribbon cables that connect the trim pieces damaged or is not connected.
- The pins that connect the left and right electronics cover is damaged or not connected.
- The pins that connect the left and right top trim is damaged or not connected.

Solution

1. Open Windows Device Manager, and click the "Human Interface Devices" drop-down menu. Confirm there is an entry for "HID-compliant touch screen". If one is not present, the internal connections for the touch sensor may not be properly connected. If a touch screen is detected, proceed to section 31.9.
2. With two people, remove the bottom screws that hold the front cover, and gently open it from the top, rotating the top edge away from the display. Verify the internal USB connection is connected, and check Windows Device Manager, Human Interface Device again.
3. If there is still no entry, disconnect the internal USB cable, and while one person holds the cover in place, a second person will connect the Windows PC directly to the front cover's USB cable.

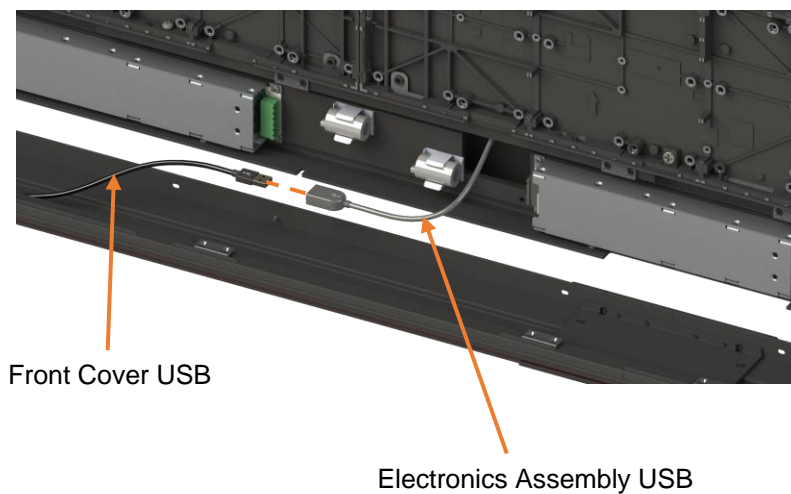

4. Once the PC is directly connected, if "HID-compliant touch screen" is still not present in Device Manager, the issue may be located within the electronics assembly. Contact Planar support for further guidance.

31.9 Erratic, Inaccurate, or Poor Touch Behavior

If the touch sensor is present in the PC's device manager, but the touch is performance is erratic.

Note: Please complete all prior troubleshooting steps described in section 31.2 before disassembling the side trim pieces

Possible Cause

Flex cable connection or PCB connections are damaged or not fully inserted.

Solution

1. Verify there is no debris covering the touch sensor lens around the perimeter of the display image.
2. Verify that all screws are installed holding the touch sensor in alignment.
3. Verify there is nothing around the touch sensor that is causing it to not attach properly.
4. One at a time starting with the upper left corner, verify the touch flex cable connection is connected properly and there is no damage to the cables.
5. One at a time starting at the top, verify that the connectors in the middle of the trim are fully connected and not damaged.

31.10 No Audio out of Right Speaker

Possible Cause

The audio connection between left and right electronics boxes is not connected.

Solution

Remove AC power from the system, remove the front cover and reinstall the cable.

Accessing Planar's Technical Support Website

Go to <http://www.planar.com/support/> to access the following support documents and resources:

- User Manual
- RS232 User Manual
- Outline drawings
- Standard warranties
- Planar support hotline number and email
- Firmware (contact Planar support via email or phone)

Regulatory Information

Manufacturer's Name: Planar Systems, Inc.
Manufacturer's Address: 1195 NE Compton Drive, Hillsboro, OR 97006
Declares that the product: Planar UltraRes L Series

Conforms with the provisions of:

Council Directive 2014/30/EU on Electromagnetic Compatibility;

EN55032 Radiated and Conducted Emissions from Multimedia Equipment

EN55035 Immunity of Multimedia Equipment
Including: EN61000-4-2 Electrostatic Discharge
EN61000-4-3 Radiated Immunity
EN61000-4-4 Electrical Fast Transients
EN61000-4-5 Line Surge
EN61000-4-6 RF Conducted Susceptibility
EN61000-4-8 Magnetic Field Immunity
EN61000-4-11 Voltage Dips and Interrupts
And: EN61000-3-2 Harmonic Current Emissions
EN61000-3-3 Voltage fluctuations and Flicker

Council Directive 2014/35/EU on Low Voltage Equipment Safety:

EN62368-1 Safety of audio/video, information and communication technology equipment

The Technical Construction File required by this Directive is maintained at the corporate headquarters of Planar Systems, Inc., 1195 NE Compton Drive, Hillsboro, OR 97006.

Note: This equipment has been tested and found to comply with the limits for a Class A digital device, pursuant to part 15 of the FCC Rules. These limits are designed to provide reasonable protection against harmful interference when the equipment is operated in a commercial environment. This equipment generates, uses, and can radiate radio frequency energy and, if not installed and used in accordance with the instruction manual, may cause harmful interference to radio communications. Operation of this equipment in a residential area is likely to cause harmful interference in which case the user will be required to correct the interference at his own expense.

Industry Canada (ICES-003): This Class A digital apparatus complies with Canadian ICES-003.
Cet appareil numérique de la classe A est conforme à la norme NMB-003 du Canada.

RoHS: Planar UltraRes L Series components are fully compliant with the directive 2011/65/EU as amended by commission delegated directive (EU) 2015/863

Any changes or modifications to the display not expressly approved by Planar could void the user's authority to operate this equipment.

ADA Compliance Statement

Some Planar UltraRes L Series models are compliant with the Americans with Disabilities Act, Section 4.